



Grove Manitowoc National Crane Potain



Grove GMK5165-2

Product Guide



Features

- 130 t (165 USt) capacity
- 12,9 m - 60 m (42 ft - 197 ft) six-section full power MEGAFORM™ boom with TWIN-LOCK™ pinning
- 11 m - 18 m (36 ft - 59 ft) bi-fold lattice swingaway, hydraulic luffing or manual offset
- 3,6 m (12 ft) three-sheave heavy duty jib, hydraulic luffing integrated in swingaway
- 390 kW (523 hp) Mercedes OM 502 LA 8-cylinder turbo-charged diesel engine. Daimler Chrysler, 16-speed G240-16 transmission
- Independent hydro-pneumatic MEGATRAK™ suspension



Features

MEGATRAK™

The MEGATRAK™ suspension system is the best off road driveline available on the market today. The system's versatility and performance allows the GMK5135 to operate as a true all-terrain crane. The MEGATRAK™ independent suspension and all-wheel steer system allows wheels to remain on the ground at all times so stresses and weight are not continually transferred between axles. MEGATRAK™ provides true ground clearance where others just raise the chassis.

Other benefits of the MEGATRAK™ system are:

- A reliable suspension system
- Excellent job site maneuverability with all-wheel steering
- Commonality among almost all models
- A driveline that remains aligned at all times
- A steering linkage system that is protected against damage
- Constant tire contact for equal tire wear
- Reduced maintenance



TWIN-LOCK™

Boom pinning mechanism automatically pins the sections in position using two horizontal pins.

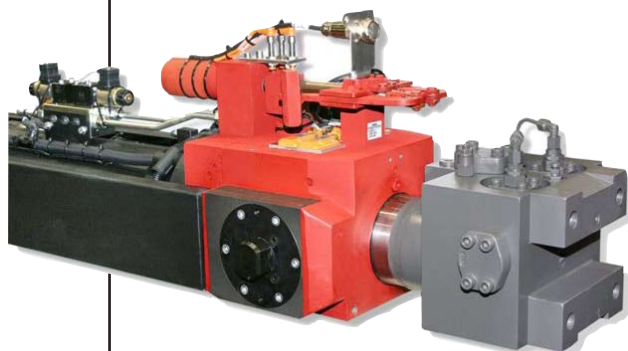

EKS 5 Light

Monitoring the lifting condition of the crane at all times EKS works together with, but independently of the ECOS as a complete command and control system or separately as a load moment indicator.

ECOS

Electronic Crane Operating System - ECOS enables control of the entire crane's principle operations. Simple programming eases lift planning and a supply of essential information allows full concentration on the lift itself.





Contents

Specifications	4
Dimensions	7
Weight proposals	8
Counterweight	9
Working range (main boom)	10
Load charts (main boom)	11
Working range (swingaway and inserts)	13
Load charts (hydraulically offsettable swingaway)	14
Working range (heavy duty jib)	16
Load charts (heavy duty jib)	17
Symbols glossary	19



Specifications

Superstructure



Boom

12,9 m - 60,0 m (42 ft - 197 ft) six-section, full power MEGAFORM™ boom with patented TWIN-LOCK™ boom pinning system.

Maximum tip height: 63 m (207 ft).



Boom nose

Eight nylatron sheaves, mounted on heavy duty tapered roller bearings with removable pin-type rope guards. Quick reeve boom nose. Removable auxiliary boom nose with removable pin type rope guard.



Boom elevation

Single lift cylinder with safety valve provides boom angle from -3° to +83°.



Hydraulic offsettable lattice extension

11 m - 18 m (36 ft - 59 ft) bifold lattice swingaway extension **hydraulically offsettable** and luffing under load: 0° - 40°. Controlled from the crane cab. Maximum tip height: 81 m (266 ft)



*Offsettable lattice extension

11 m - 18 m (36 ft - 59 ft) bifold lattice swingaway extension manually offset: 0°, 20° or 40°. Maximum tip height: 81 m (266 ft)



Lattice inserts

One 8 m (26 ft) and one 6 m (20 ft) insert for use with lattice swingaway extension. Increases extension length to 26 m (85 ft) or 32 m (105 ft).



Load moment and anti-two block system

Load moment and anti-two block system with audio/visual warning and control lever lockout provides electronic display of boom angle, length, radius, tip height, relative load moment, maximum permissible load, load indication and warning of impending two-block condition.



Cab

All aluminum construction cab with acoustical lining, tinted safety glass, adjustable operator's seat, opening windows in side and cab rear, hinged front window with wiper, sunvisor and window shade. Other features include hot water heater, armrest integrated crane controls, and ergonomically arranged instrumentation.



Crane control system

Full electronic control of all crane movements using electrical control levers with automatic reset to zero. Controls are integrated with the LMI and engine management system by CAN-BUS. ECOS system with graphic display.



Swing

Two planetary gears with axial piston motors. Infinitely variable to 1.5 rpm. Holding and service brake.



Counterweight

40 100 kg (88,400 lb) consisting of various sections with hydraulic installation/removal system. Controlled from the superstructure cab.



Engine

Mercedes-Benz OM 904 LA diesel, four-cylinders, water cooled, turbocharged with 129 kW (173 bhp) at 2200 rpm.

Max torque: 675 Nm (498 ft/lb) at 100 rpm.

Engine emission: EUROMOT/EPA/CARB (non road).



Fuel tank capacity

200 L (53 gal)



Hydraulic system

Two separate circuits, one axial piston variable displacement pump (load sensing) with electronic power limiting control and one gear pump for swing. Dual thermostatically controlled oil coolers keep oil at optimum operating temperature.

Tank capacity: 840 L (222 gal)



Specifications

Superstructure continued



Hoist

Main and auxiliary hoists are powered by axial piston motor with planetary gear and brake. "Thumb-thumper" hoist drum rotation indicator alerts operator of hoist movement.

	Main	Auxiliary
Line length:	255 m (837 ft)	225 m (738 ft)
Rope diameter:	19 mm	19 mm
Line speed:	120 m/min (394 fpm)	120 m/min (394 fpm)
Line pull:	70 kN (15,700 lb)	70 kN (15,700 lb)



Electrical system

24V system with three phase alternator, 28V/80A. 2 batteries, 12V/170 Ah.

*Optional equipment

- ▶ 3,6 m (11.8 ft) side-stowed three-sheave heavy-duty jib integrated in swingaway.
- ▶ Work light, mounted on top of base section.
- ▶ Cab controlled work lights mounted to top of base section.
- ▶ Stainless steel exhaust system with spark arrestor in lieu of standard.
- ▶ Engine independent diesel cab heater, also serves as engine preheater including 24-hour timer.
- ▶ Engine independent propane gas cab heater.
- ▶ Stereo/radio CD player.
- ▶ Outrigger pad load indicator with readout both in superstructure cab and carrier.
- ▶ Air conditioning.
- ▶ Working range limiter.
- ▶ Boom mounted aircraft warning light.
- ▶ Drive and steer control for superstructure.
- ▶ EKS5 with full graphic display.

Carrier



Chassis

Box type, torsion resistant frame is fabricated from high strength steel.



Outrigger system

Four hydraulic single stage outrigger beams with vertical cylinders and outrigger pads, 600 mm (23.6 in) square. Outriggers can be set in five positions:

Full:	7,5 m (24.6 ft)
Partial:	6,7 m (22.0 ft)
	5,9 m (19.4 ft)
	5,1 m (16.7 ft)
Retracted:	2,5 m (8.2 ft)

Independent horizontal and vertical movement controlled from each side of carrier. Electronic crane level indicators.



Engine

Mercedes-Benz OM 502 LA eight cylinder, water cooled, turbo-charged, with 390 kW (523 bhp) at 1800 rpm. Max. torque 2400 Nm (1770 fpm) at 1200 rpm.

Engine emissions: EUROMOT/EPA/CARB (off road) Compression and exhaust brakes.



Fuel tank capacity

400 L (106 gal)



Transmission

Daimler Chrysler, 16 speed G240-16 with EPS (Electric Pneumatic Shifting) and two-stage transfer case.



Drive/steer

10x6x10



Axles

1st axle line – steer

2nd axle line – drive/steer

3rd axle line – steer (additional drive)

4th axle line – drive/steer (connects for all wheel steer)

5th axle line – drive/steer

Drive axles with planetary hub reduction and center mounted differential-gearing. Inter-axle and cross axle differential locks.



Specifications

Carrier continued



Suspension

Exclusive MEGATRAK™ suspension. Independent hydro-pneumatic system acting on all wheels with hydraulic lockout. Suspension can be raised 170 mm (6.5 in) or lowered 130 mm (5 in) both longitudinally and transversely. Features an automatic leveling system for highway travel.



Tires

10 tires, 16.00R25



Steering

Dual circuit, hydraulic power assisted steering system. Transfer case mounted, ground driven emergency steering pump. Axles 1, 2, 3 and 5 steer on highway. Separate steering of the 4th and 5th axles for all wheel and crab steering, controlled by an electronic rocker switch.



Brakes

Service brakes: pneumatic dual circuit acting on all wheels, anti lock prevention.
Parking brake: pneumatically operated spring loaded brake acting on axle lines 2, 4 and 5.
Air dryer.



Cab

Two-man construction with the following features: safety glass, driver seat with suspension, power windows, heated rear view mirrors, engine independent diesel cab heater with 24-hour timer, AC, complete instrumentation and driving controls.

ECOS control of suspension, drive connect and disconnect, inter-axle locks, differential locks and all-wheel steer.



Electrical system

24V system with three phase alternator, 28V/100A
2 batteries, 12V/170 Ah



Maximum speed

85 km/h (53 mph)



Gradeability (theoretical)

60% - 14.00 R25 tires
54% - 16.00 / 20.5 R25 tires

Miscellaneous standard equipment

Work light; tool kit; fire extinguisher; auxiliary boom nose; radio/CD player in carrier cab, cruise control, wind speed indicator and working lights for each outrigger beam.

*Optional equipment

- ▶ Stainless steel exhaust system with spark arrestor
- ▶ 14.00 R25 (vehicle width, 2,75 m [9 ft])
- ▶ 20.5 R25 tires (vehicle width, 3,0 m [9.8 ft])
- ▶ 10x8x10 drive/steer
- ▶ Electric driveline retarder
- ▶ Steel outrigger floats
- ▶ Spare tire with carry bracket
- ▶ Outrigger pad load indicator
- ▶ Hinged bunk bed
- ▶ Trailer and towing hitches
- ▶ Additional strobe lights
- ▶ Rear mounted stowage box



Dimensions

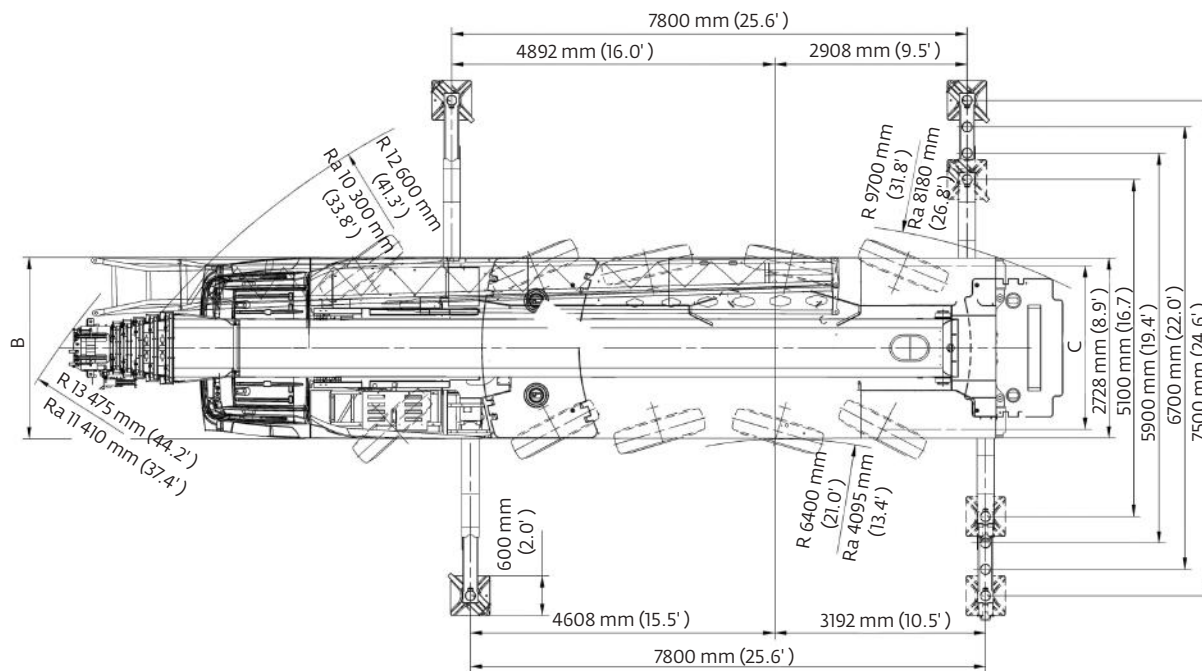
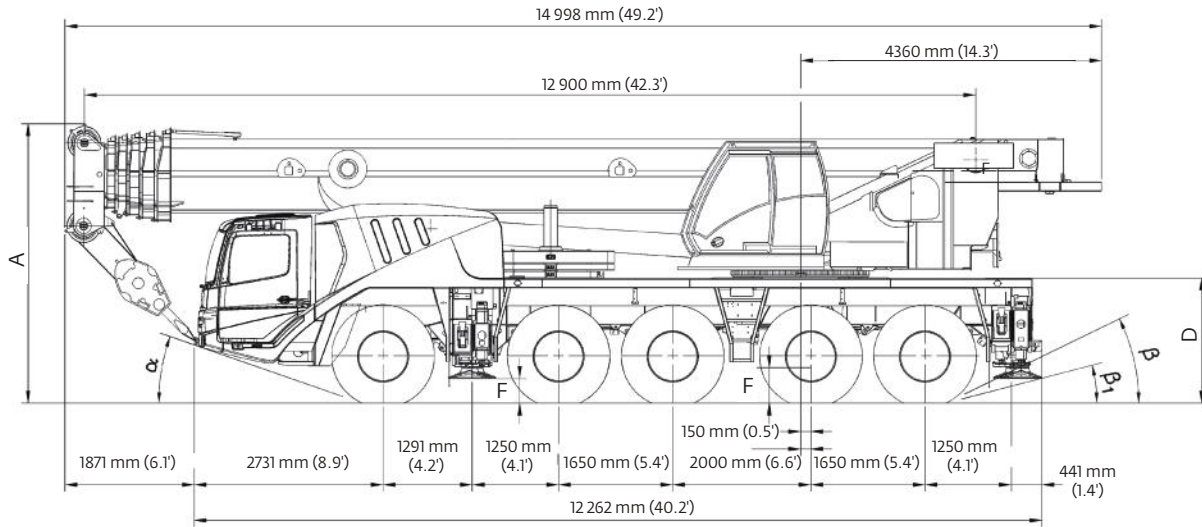

	A	A *130 mm (5.1")	B	C	D	E	F	α	β	β_1
14.00 R25	3945 (12.9)	3815 (12.5)	2750 (9.0)	2338 (7.7)	1750 (5.7)	435 (1.4)	356 (1.2)	18°	23°	17°
16.00 R25	3995 (13.1)	3865 (12.7)	3000 (9.8)	2486 (8.2)	1800 (5.9)	485 (1.6)	386 (1.3)	20°	25°	19°
20.5 R25	3995 (13.1)	3865 (12.7)	3000 (9.8)	2507 (8.2)	1800 (5.9)	485 (1.6)	386 (1.3)	20°	25°	19°

Ra = Radius all wheels steered
*Lowered



Weight proposals

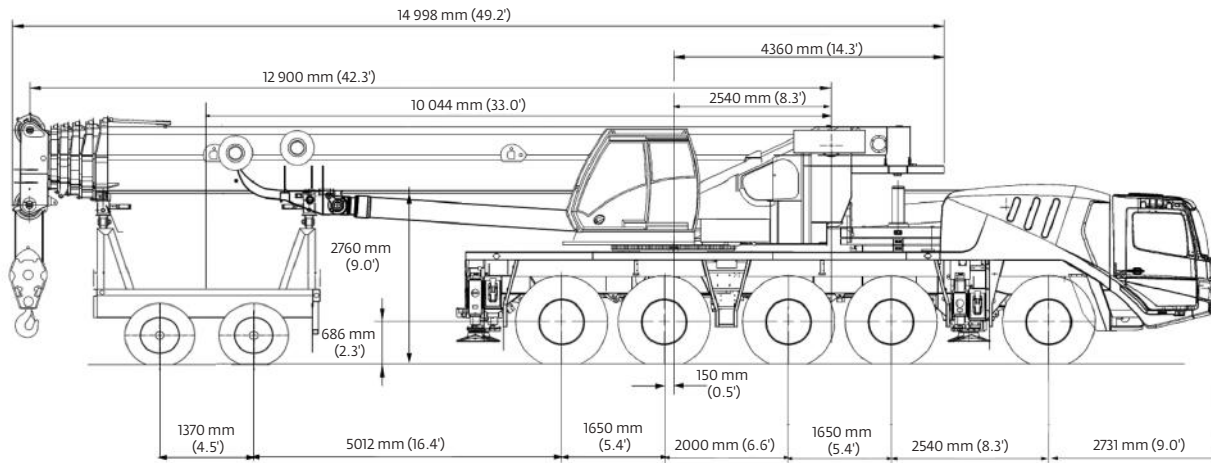

Basic weights - kg (lb)	Axles 1 and 2		Axles 3-5		2 Dolly axles		Total	
GMK 5165-2 Mercedes power with: 16.00R25 tires, 10x8x10 drive/steer, 36 ft - 59 ft hydraulic luffing swingaway, 2nd oil cooler, outrigger pads, auxiliary hoist, driver and tanks filled, 2 axle boom dolly (2994 kg [6600 lb])	18 011	(39,707)	22 319	(49,205)	14 343	(31,621)	54 673	(120,533)
Additions:								
2500 kg (5500 lb) section on superstructure or carrier (1,2,5,7)	1896	(4180)	604	(1332)			2500	(5512)
5000 kg (11,000 lb) section stowed on carrier (3,4)	3792	(8360)	1208	(2663)			5000	(11,023)
2 x 3750 kg (2 x 8300 lb) section stowed on carrier (8+9)	5689	(12,542)	1811	(3993)			7500	(16,535)
Removals:								
Brackets for hydraulic swingaway	- 13	(-29)	- 12	(-26)	- 61	(-134)	- 86	(-190)
Hose reel + parts for hydraulic swingaway	- 7	(-15)	- 6	(-13)	- 196	(-432)	- 210	(-463)
11 m - 18 m (36 ft - 59 ft) hydraulic swingaway	- 197	(-434)	- 171	(-377)	- 1376	(-3034)	- 1744	(-3845)
Front outriggers	- 1379	(-3040)	- 6	(-13)			- 1385	(-3053)
Rear outriggers	926	(2041)	- 2400	(-5291)			- 1474	(-3250)
Front and rear outrigger floats	- 37	(-82)	- 163	(-359)			- 200	(-441)
Substitutions:								
10x6x10 drive/steer	- 43	(-95)	- 65	(-143)			- 108	(-238)
14.00R25 tires	- 240	(-529)	- 360	(-794)			- 600	(-1323)
16.00R25 tires	172	(379)	258	(569)			430	(948)

Boom over front

Basic weights - kg (lb)	Axles 1 and 2		Axles 3-5		Total	
GMK 5165-2 Mercedes power with: 16.00R25 tires, 10x6x10 drive/steer, 2nd oil cooler, outrigger pads, auxiliary hoist, driver and tanks filled	20 220	(44,578)	29 362	(64,732)	49 582	(109,310)
Additions:						
10x8x10 drive/steer	43	(95)	65	(143)	108	(238)
Electric driveline retarder	- 74	(-163)	334	(736)	260	(573)
Spare wheel 14.00 R25 XGC steel rim with stowage	- 198	(-437)	457	(1008)	259	(571)
Spare wheel 16.00 R25 XGC steel rim with stowage	- 244	(-538)	563	(1,241)	319	(703)
Spare wheel 20.5 R25 XGC steel rim with stowage	- 277	(-611)	639	(1409)	362	(798)
Brackets for hydraulic swingaway	82	(181)	4	(9)	86	(190)
Hose reel + parts for hydraulic swingaway	301	(664)	- 91	(-201)	210	(463)
11 m-18 m (36 ft - 59 ft) hydraulic swingaway	1968	(4339)	- 224	(-494)	1744	(3845)
Auxiliary boom nose	149	(328)	- 79	(-174)	70	(154)
5000 kg (11,000 lb) slab fixed to turntable (special counterweight version)	- 2759	(-6083)	7759	(17,106)	5000	(11,023)
2500 kg (5500 lb) section pinned to superstructure (5,7)	- 1862	(-4105)	4362	(9617)	2500	(5512)
2500 kg (5500 lb) section stowed on carrier (1,2)	1896	(4180)	604	(1332)	2500	(5512)
5000 kg (11,000 lb) section stowed on carrier (3,4)	3793	(8362)	1207	(2661)	5000	(11,023)
2 x 3760 kg (2 x 8300 lb) section stowed on carrier (8,9)	5689	(12,542)	1811	(3993)	7500	(16,535)
Substitutions:						
14.00R25 tires	- 240	(-529)	- 360	(-794)	- 600	(-1323)
20.5R25 tires	172	(379)	258	(569)	430	(948)
Removals:						
Boom assembly	- 11 677	(-25,743)	- 3541	(-7807)	- 15 218	(-33,550)
Front outriggers	- 1379	(-3040)	- 6	(-13)	- 1385	(-3053)
Rear outriggers	926	(2041)	- 2400	(-5291)	- 1474	(-3250)
Front and rear outrigger floats	- 37	(-82)	- 163	(-359)	- 200	(-441)



Counterweight

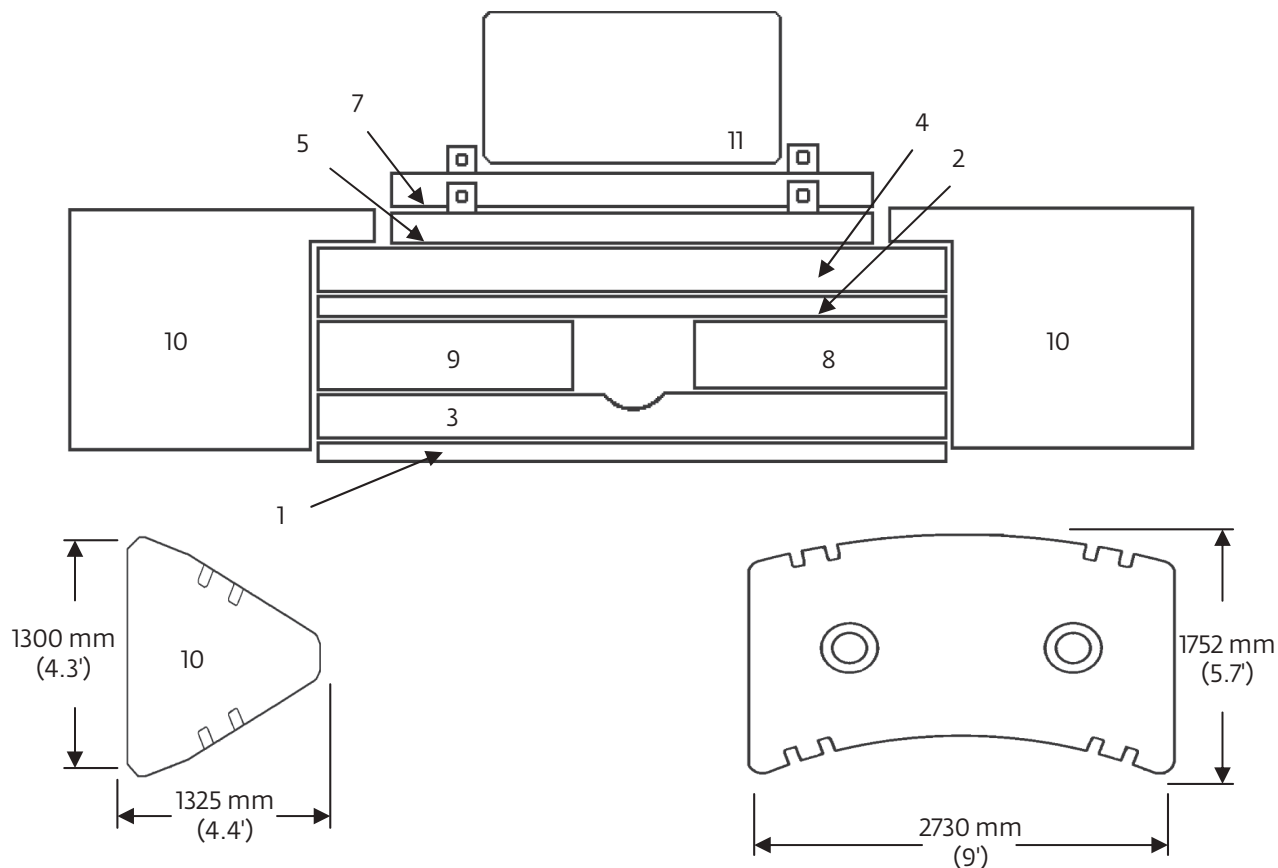

- | | |
|---------------------------------|---|
| 1. 2500 kg (5500 lb) baseplate | 7. 2500 kg (5500 lb) pinned |
| 2. 2500 kg (5500 lb) stacking | 8. 3750 kg (8300 lb) stacking |
| 3. 5000 kg (11,000 lb) stacking | 9. 3750 kg (8300 lb) stacking |
| 4. 5000 kg (11,000 lb) stacking | 10. 5770 kg (12,700 lb) wing |
| 5. 2500 kg (5500 lb) pinned | 11. 1000 kg (2200 lb) bolted (auxiliary hoist or IPO) |

	1	2	3	4	5	7	8	9	10	11
Counterweight configuration kg (lb)										
1000 (2200)										•
3500 (7700)						•				•
6000 (13,200)					•	•				•
8500 (18,700)	•				•	•				•
11 000 (24,200)	•						•	•		•
13 500 (29,700)	•					•	•	•		•
16 000 (35,200)	•				•	•	•	•		•
18 500 (40,700)	•		•			•	•	•		•
21 000 (46,200)	•		•		•	•	•	•		•
23 500 (51,800)	•	•	•		•	•	•	•		•
26 000 (57,300)	•		•	•	•	•	•	•		•
28 500 (62,800)	•	•	•	•	•	•	•	•		•
40 100 (88,400)	•	•	•	•	•	•	•	•	2x	•



Working range

42 ft -197 ft main boom

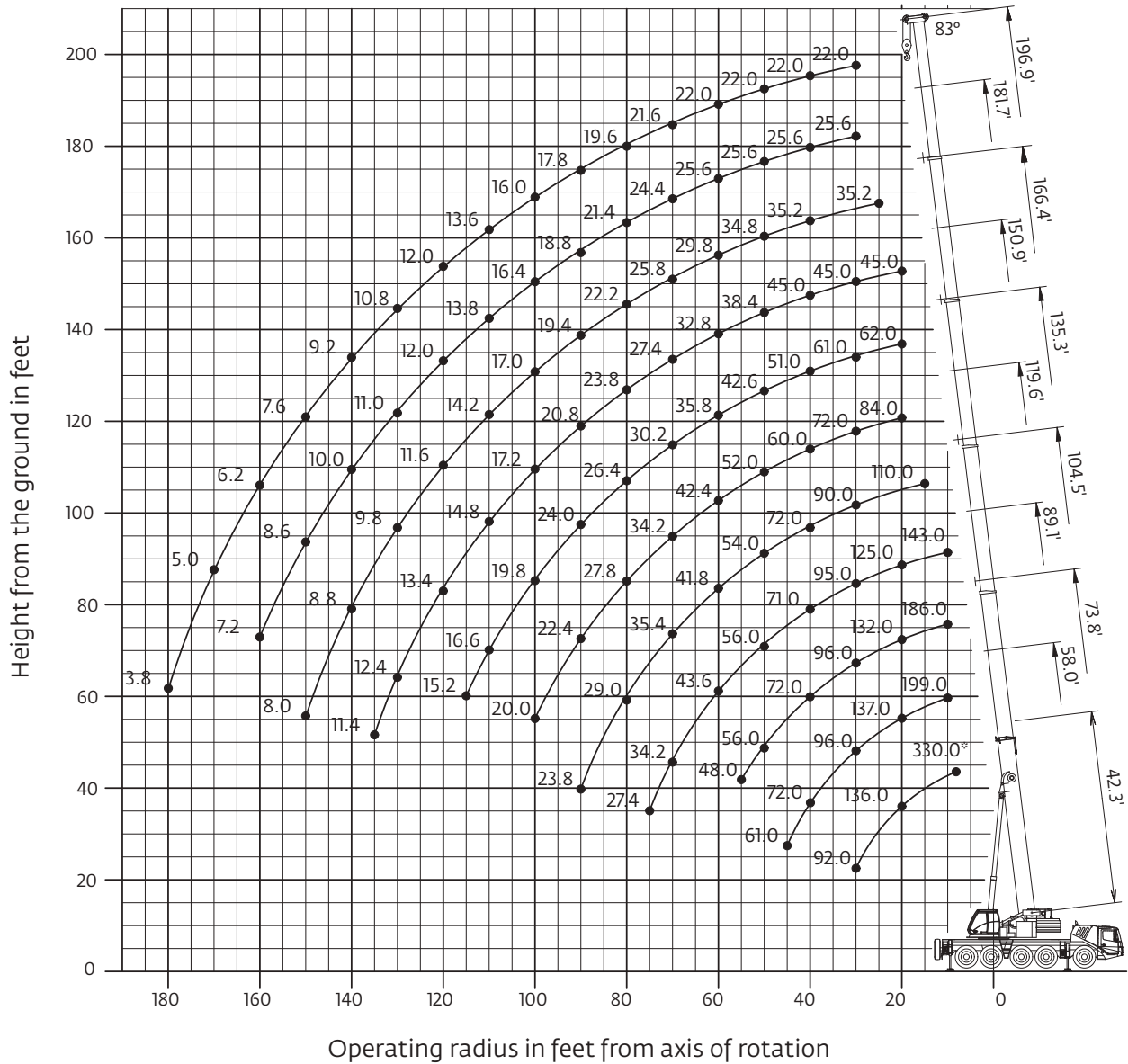

	Hook block	H
	100 USt, 7 sheave	3160 mm (10.4 ft)
	80 USt, 5 sheave	3070 mm (10.1 ft)
	45 USt, 3 sheave	3000 mm (9.8 ft)
	20 USt, 1 sheave	2770 mm (9.1 ft)
	12 USt, single line headache ball	2350 mm (7.7 ft)

Hook heights shown in the working range diagram do not consider loaded boom deflection.

THIS CHART IS ONLY A GUIDE AND SHOULD NOT BE USED TO OPERATE THE CRANE.

The individual crane's load chart, operating instructions and other instructional plates must be read and understood prior to operating the crane





Load charts



Main boom

12,9 m - 60,0 m
 (42.3 ft - 196.9 ft)

40 100 kg
 (88,400 lb)



25.6 ft x 24.6 ft spread
 (100%)



360°



Pounds x 1000

Feet	42.3	58.0	73.8	89.1	104.5	119.6	135.3	150.9	166.4	181.7	196.9
8.0	330.0*										
10.0	215.0	199.0	186.0	143.0							
15.0	168.0	165.0	154.0	143.0	110.0						
20.0	136.0	137.0	132.0	125.0	108.0	84.0	62.0	45.0			
25.0	113.0	114.0	114.0	110.0	98.0	78.0	62.0	45.0	35.2		
30.0	92.0	96.0	96.0	95.0	90.0	72.0	61.0	45.0	35.2	25.6	22.0
35.0		83.0	83.0	82.0	82.0	66.0	56.0	45.0	35.2	25.6	22.0
40.0		72.0	72.0	71.0	72.0	60.0	51.0	45.0	35.2	25.6	22.0
45.0		61.0	63.0	62.0	62.0	56.0	47.0	41.4	35.2	25.6	22.0
50.0			56.0	56.0	54.0	52.0	42.6	38.4	34.8	25.6	22.0
55.0			48.0	50.0	47.0	48.0	39.2	35.6	32.4	25.6	22.0
60.0				43.6	41.8	42.4	35.8	32.8	29.8	25.6	22.0
65.0				38.4	37.6	38.0	32.6	29.8	27.8	25.6	22.0
70.0				34.2	35.4	34.2	30.2	27.4	25.8	24.4	21.6
75.0				27.4	32.2	31.0	28.0	25.4	24.0	23.0	20.6
80.0					29.0	27.8	26.4	23.8	22.2	21.4	19.6
85.0					26.4	25.0	25.2	22.0	20.8	20.0	18.6
90.0					23.8	22.4	24.0	20.8	19.4	18.8	17.8
95.0						21.0	21.8	19.0	18.2	17.6	17.0
100.0						20.0	19.8	17.2	17.0	16.4	16.0
105.0							18.0	15.8	15.6	15.0	14.8
110.0							16.6	14.8	14.2	13.8	13.6
115.0							15.2	14.0	13.0	12.8	12.8
120.0								13.4	11.6	12.0	12.0
125.0								12.8	10.4	11.6	11.4
130.0								12.4	9.8	11.0	10.8
135.0								11.4	9.4	10.4	10.0
140.0									8.8	10.0	9.2
145.0									8.4	9.4	8.4
150.0									8.0	8.6	7.6
155.0										7.8	6.8
160.0										7.2	6.2
165.0											5.6
170.0											5.0
175.0											4.4
180.0											3.8



*Over rear with special equipment

12,9 m - 60,0 m
 (42.3 ft - 196.9 ft)

21 000 kg
 (46,200 lb)

25.6 ft x 24.6 ft spread
 (100%)

360°



Pounds x 1000

Feet	42.3	58.0	73.8	89.1	104.5	119.6	135.3	150.9	166.4	181.7	196.9
10.0	210.0	199.0	186.0	143.0							
15.0	164.0	164.0	154.0	143.0	110.0						
20.0	130.0	131.0	131.0	125.0	108.0	84.0	62.0	45.0			
25.0	107.0	108.0	101.0	93.0	90.0	78.0	62.0	45.0	35.2		
30.0	85.0	86.0	78.0	76.0	71.0	70.0	61.0	45.0	35.2	25.6	22.0
35.0		69.0	65.0	62.0	61.0	57.0	54.0	45.0	35.2	25.6	22.0
40.0		55.0	55.0	52.0	52.0	48.0	45.0	43.0	35.2	25.6	22.0
45.0		47.0	47.0	45.0	44.0	41.0	41.0	36.8	35.2	25.6	22.0
50.0			40.0	40.6	38.2	35.6	35.8	31.6	31.0	25.6	22.0
55.0			35.2	35.4	33.4	32.8	31.4	28.2	26.8	25.6	22.0
60.0				30.8	29.4	30.0	27.6	26.4	23.4	23.8	22.0
65.0				26.8	26.0	26.8	24.4	24.6	21.6	22.4	21.2
70.0				23.6	22.8	24.0	21.8	22.0	20.2	20.6	19.0
75.0				15.2	20.0	21.6	19.4	19.6	19.0	18.4	16.8
80.0					17.6	19.2	17.4	17.8	17.8	16.6	15.0
85.0					15.6	17.0	15.6	16.0	16.2	14.8	13.4
90.0					13.8	15.2	14.0	14.4	14.6	13.4	12.0
95.0						13.6	12.4	13.2	13.2	12.0	10.6
100.0						12.8	11.0	12.4	12.0	10.8	9.4
105.0							10.4	11.6	11.0	9.8	8.4
110.0							9.8	10.4	9.8	8.8	7.4
115.0							9.2	9.4	8.8	7.8	6.6
120.0								8.4	7.8	7.0	5.8
125.0								7.6	7.0	6.2	5.0
130.0								6.8	6.2	5.4	4.2
135.0								6.2	5.4	4.6	3.6
140.0									4.8	4.0	3.0
145.0									4.2	3.4	2.4
150.0									3.6	2.8	2.4
155.0										2.2	2.2

THIS CHART IS ONLY A GUIDE AND SHOULD NOT BE USED TO OPERATE THE CRANE.



Load charts

Main boom

12,9 m - 60,0 m
(42.3 ft - 196.9 ft)13 200 kg
(6000 lb)25.6 ft x 24.6 ft spread
(100%)

360°



Pounds x 1000

Feet	42.3	58.0	73.8	89.1	104.5	119.6	135.3	150.9	166.4	181.7	196.9
10.0	206.0	199.0	186.0	143.0							
15.0	157.0	158.0	146.0	127.0	110.0						
20.0	111.0	104.0	96.0	88.0	84.0	76.0	62.0	45.0			
25.0	77.0	74.0	70.0	69.0	63.0	58.0	56.0	45.0	35.2		
30.0	56.0	57.0	56.0	53.0	49.0	49.0	45.0	40.8	35.2	25.6	22.0
35.0		45.0	45.0	42.8	39.6	39.8	36.2	35.6	30.0	25.6	22.0
40.0		36.4	36.6	35.0	32.2	32.6	29.6	30.2	29.0	24.2	22.0
45.0		29.0	30.6	30.4	26.6	28.4	26.2	26.0	24.4	22.4	20.2
50.0			25.8	26.2	23.6	24.8	23.6	22.2	20.6	18.8	17.0
55.0			21.2	22.4	21.8	21.4	20.2	19.0	17.6	16.0	14.2
60.0				19.2	19.0	18.4	17.4	16.4	15.0	13.6	11.8
65.0				16.4	16.6	16.0	15.2	14.2	13.0	11.6	10.0
70.0				14.0	14.4	14.0	13.2	12.2	11.2	9.8	8.2
75.0				4.4	12.4	12.4	11.6	10.6	9.6	8.2	6.8
80.0					10.6	10.8	10.0	9.2	8.2	7.0	5.6
85.0					9.2	9.4	8.8	8.0	7.0	5.8	4.4
90.0					7.8	8.0	7.6	6.8	5.8	4.8	3.4
95.0						7.0	6.6	5.8	5.0	3.8	2.4
100.0						6.0	5.6	5.0	4.0	3.0	
105.0							4.8	4.2	3.2	2.2	
110.0							4.0	3.4	2.6		
115.0							3.2	2.8			

12,9 m - 60,0 m
(42.3 ft - 196.9 ft)2200 kg
(1000 lb)25.6 ft x 24.6 ft spread
(100%)

360°



Pounds x 1000

Feet	42.3	58.0	73.8	89.1	104.5	119.6	135.3	150.9	166.4	181.7	196.9
10.0	204.0	199.0	186.0	143.0							
15.0	153.0	142.0	124.0	114.0	100.0						
20.0	94.0	88.0	82.0	79.0	72.0	65.0	58.0	45.0			
25.0	64.0	64.0	62.0	58.0	53.0	52.0	47.0	41.8	35.2		
30.0	47.0	48.0	47.0	44.0	40.4	40.2	36.2	36.2	29.8	25.6	22.0
35.0		36.4	36.8	36.6	31.8	34.0	32.0	29.8	27.8	24.2	22.0
40.0		28.6	29.4	29.6	28.4	27.6	26.2	24.4	22.6	20.6	18.4
45.0		22.2	24.0	24.4	23.8	23.0	21.8	20.4	18.8	16.8	15.0
50.0			19.8	20.4	20.0	19.4	18.2	17.0	15.6	14.0	12.0
55.0			16.0	17.2	16.8	16.4	15.4	14.2	13.0	11.4	9.8
60.0				14.6	14.4	14.0	13.0	12.0	10.8	9.4	7.8
65.0				12.2	12.2	12.0	11.2	10.2	9.0	7.8	6.2
70.0				10.2	10.4	10.2	9.4	8.6	7.6	6.2	4.8
75.0					8.8	8.8	8.0	7.2	6.2	5.0	3.6
80.0					7.4	7.4	6.8	6.0	5.0	3.8	2.4
85.0					6.2	6.4	5.6	5.0	4.0	2.8	
90.0					5.0	5.2	4.8	4.0	3.0		
95.0						4.2	3.8	3.2	2.2		
100.0						3.4	3.0	2.4			
105.0							2.4				



Working range

42 ft - 197 ft main boom with hydraulic 36 ft and 59 ft swingaway, 1x26 ft and 1x20 ft insert

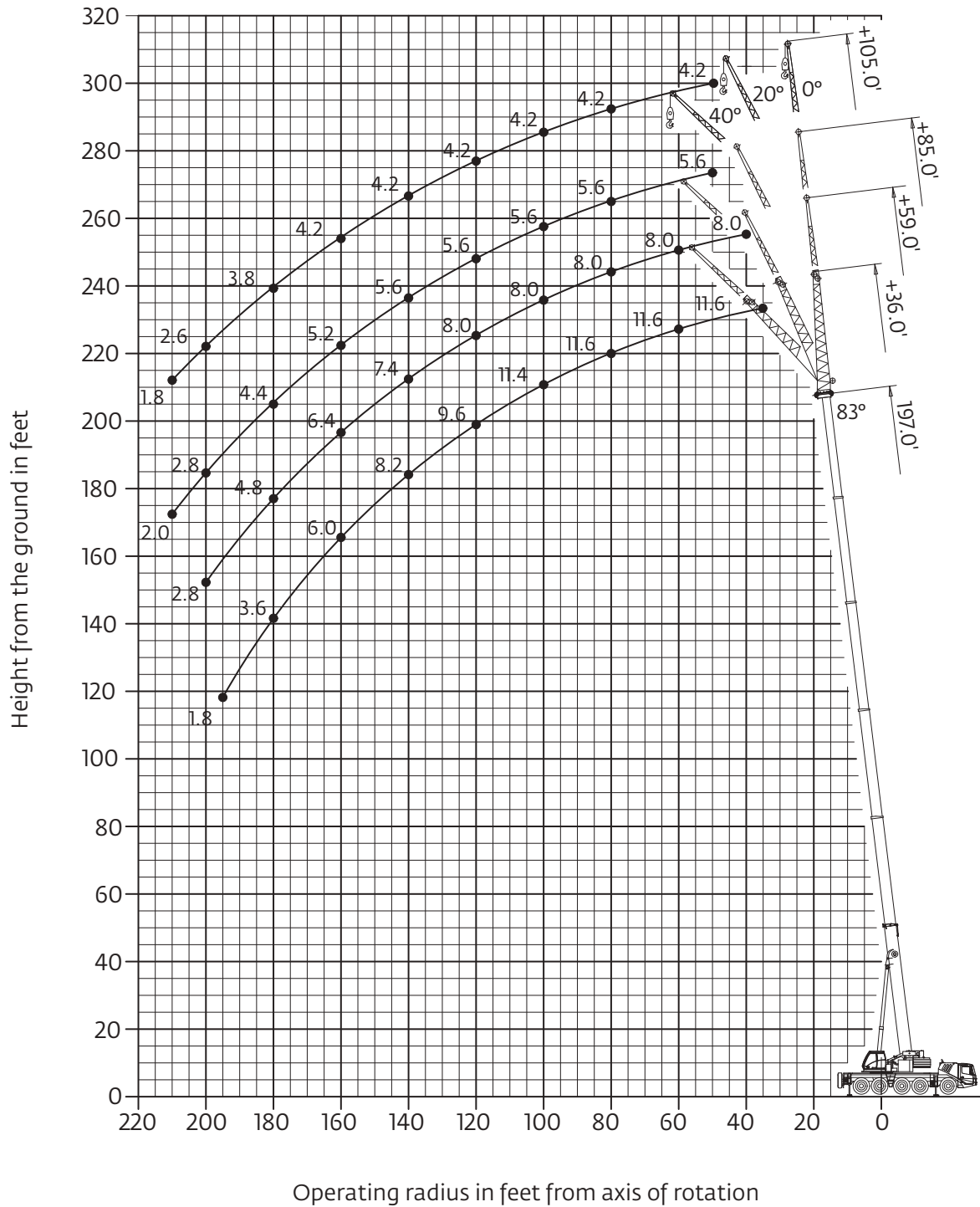

Hook heights shown in the working range diagram do not consider loaded boom deflection.



Load charts

Hydraulic offsettable swingaway

Intermediate angle

Intermediate angle												
60 m (197 ft)	11-18-26-32 m (36-59-85-105 ft)	40 100 kg (88,400 lb)	25.6 ft x 24.6 ft spread 100%	360°								
	Pounds x 1000											
Feet	197' + 36'			197' + 59'			197' + 85'			197' + 105'		
	0°	0°-20°	20°-40°	0°	0°-20°	20°-40°	0°	0°-20°	20°-40°	0°	0°-20°	20°-40°
30.0												
35.0	11.6											
40.0	11.6			8.0								
45.0	11.6			8.0								
50.0	11.6	11.6		8.0			5.6			4.2		
55.0	11.6	11.6	11.6	8.0			5.6			4.2		
60.0	11.6	11.6	11.6	8.0	8.0		5.6			4.2		
65.0	11.6	11.6	11.6	8.0	8.0		5.6			4.2		
70.0	11.6	11.6	11.6	8.0	8.0		5.6	5.6		4.2		
75.0	11.6	11.6	11.6	8.0	8.0		5.6	5.6		4.2	4.2	
80.0	11.6	11.6	11.6	8.0	8.0	8.0	5.6	5.6		4.2	4.2	
85.0	11.6	11.6	11.6	8.0	8.0	8.0	5.6	5.6		4.2	4.2	
90.0	11.6	11.6	11.6	8.0	8.0	8.0	5.6	5.6	5.6	4.2	4.2	4.0
95.0	11.6	11.6	11.6	8.0	8.0	8.0	5.6	5.6	5.6	4.2	4.2	4.0
100.0	11.4	11.4	11.4	8.0	8.0	8.0	5.6	5.6	5.6	4.2	4.2	4.0
105.0	11.0	10.8	11.0	8.0	8.0	8.0	5.6	5.6	5.6	4.2	4.2	4.0
110.0	10.6	10.4	10.6	8.0	8.0	8.0	5.6	5.6	5.6	4.2	4.2	4.0
115.0	10.0	10.0	10.0	8.0	8.0	8.0	5.6	5.6	5.6	4.2	4.2	4.0
120.0	9.6	9.6	9.6	8.0	8.0	8.0	5.6	5.6	5.6	4.2	4.2	4.0
125.0	9.2	9.2	9.2	8.0	8.0	8.0	5.6	5.6	5.6	4.2	4.2	4.0
130.0	8.8	8.8	8.8	7.8	7.8	8.0	5.6	5.6	5.6	4.2	4.2	4.0
135.0	8.4	8.4	8.6	7.4	7.6	7.8	5.6	5.6	5.6	4.2	4.2	4.0
140.0	8.0	8.0	8.2	7.2	7.2	7.4	5.6	5.6	5.6	4.2	4.2	4.0
145.0	7.6	7.6	7.8	6.8	7.0	7.2	5.6	5.6	5.6	4.2	4.2	4.0
150.0	6.8	6.8	7.4	6.6	6.6	6.8	5.4	5.4	5.6	4.2	4.2	4.0
155.0	6.2	6.2	6.8	6.4	6.4	6.6	5.0	5.2	5.6	4.2	4.2	4.0
160.0	5.6	5.6	6.0	6.0	6.2	6.4	4.8	5.0	5.2	4.0	4.2	4.0
165.0	5.0	5.0	5.4	5.6	5.6	6.2	4.6	4.8	5.0	3.8	4.0	4.0
170.0	4.4	4.4	4.8	5.0	5.0	5.8	4.4	4.6	4.8	3.6	3.8	4.0
175.0	3.8	3.8	4.2	4.6	4.6	5.4	4.2	4.4	4.6	3.4	3.6	4.0
180.0	3.2	3.2	3.6	4.0	4.0	4.8	3.8	3.8	4.4	3.2	3.4	3.8
185.0	2.8	2.8		3.6	3.6	4.2	3.4	3.4	4.2	3.0	3.2	3.6
190.0	2.4	2.4		3.0	3.0	3.8	3.0	3.0	3.6	2.8	2.8	3.4
195.0	1.8	1.8		2.6	2.6	3.2	2.6	2.6	3.2	2.4	2.4	3.0
200.0				2.2	2.2	2.8	2.2	2.2	2.8	2.0	2.0	2.6
205.0									2.4			2.2
210.0									2.0			1.8

Loads for luffing

Loads for luffing										
60 m (197 ft)	11-18-26-32 m (36-59-85-105 ft)	40 100 kg (88,400 lb)	25.6 ft x 24.6 ft spread 100%	360°						
	Pounds x 1000									
Feet	197' + 36'		197' + 59'		197' + 85'		197' + 105'			
	0°-20°	20°-40°	0°-20°	20°-40°	0°-20°	20°-40°	0°-20°	20°-40°		
40.0										
45.0										
50.0	11.2									
55.0	11.2	11.2								
60.0	11.2	11.2		7.2						
65.0	11.2	11.2		7.2						
70.0	11.2	11.2		7.2			5.6			
75.0	11.2	11.2		7.2			5.6		4.2	
80.0	11.2	11.2		7.2	7.2		5.6		4.2	
85.0	11.2	11.2		7.2	7.2		5.6		4.2	
90.0	11.2	11.2		7.2	7.2		5.6	5.6	4.2	3.8
95.0	11.2	11.2		7.2	7.2		5.6	5.6	4.2	3.8
100.0	10.8	10.8		7.2	7.2		5.6	5.6	4.2	3.8
105.0	10.4	10.4		7.2	7.2		5.6	5.6	4.2	3.8
110.0	9.8	10.0		7.2	7.2		5.6	5.6	4.2	3.8
115.0	9.4	9.6		7.2	7.2		5.6	5.6	4.2	3.8
120.0	9.0	9.2		7.2	7.2		5.6	5.6	4.2	3.8
125.0	8.6	8.8		7.2	7.2		5.6	5.6	4.2	3.8
130.0	8.4	8.4		7.2	7.2		5.6	5.6	4.2	3.8
135.0	8.0	8.2		7.2	7.2		5.6	5.6	4.2	3.8
140.0	7.6	7.8		6.8	7.2		5.6	5.6	4.2	3.8
145.0	7.0	7.4		6.6	6.8		5.4	5.6	4.2	3.8
150.0	6.4	6.8		6.4	6.6		5.2	5.4	4.2	3.8
155.0	5.6	6.2		6.0	6.4		5.0	5.2	4.2	3.8
160.0	5.0	5.6		5.8	6.0		4.8	5.0	4.0	3.8
165.0	4.4	4.8		5.2	5.8		4.6	4.8	3.8	3.8
170.0	4.0	4.4		4.6	5.4		4.4	4.6	3.6	3.8
175.0	3.4	3.8		4.2	5.0		4.2	4.4	3.4	3.8
180.0	3.0	3.2		3.6	4.4		3.6	4.2	3.4	3.6
185.0	2.6			3.2	3.8		3.2	4.0	3.2	3.4
190.0	2.2			2.8	3.4		2.8	3.4	2.8	3.2
195.0				2.4	3.0		2.4	3.0	2.4	3.0
200.0				2.0	2.6		2.0	2.6	2.0	2.6
205.0								2.2		2.2

THIS CHART IS ONLY A GUIDE AND SHOULD NOT BE USED TO OPERATE THE CRANE.

The individual crane's load chart, operating instructions and other instructional plates must be read and understood prior to operating the crane



Load charts

Hydraulic offsettable swingaway

Intermediate angle

60 m
(197 ft)11-18-26-32 m
(36-59-85-105 ft)21 000 kg
(46,200 lb)25.6 ft x 24.6 ft spread
100%

360°



Pounds x 1000

Feet	197' + 36'			197' + 59'			197' + 85'			197' + 105'		
	0°	0°-20°	20°-40°	0°	0°-20°	20°-40°	0°	0°-20°	20°-40°	0°	0°-20°	20°-40°
30.0												
35.0	11.6											
40.0	11.6			8.0								
45.0	11.6			8.0								
50.0	11.6	11.6		8.0			5.6			4.2		
55.0	11.6	11.6	11.6	8.0			5.6			4.2		
60.0	11.6	11.6	11.6	8.0	8.0		5.6			4.2		
65.0	11.6	11.6	11.6	8.0	8.0		5.6			4.2		
70.0	11.6	11.6	11.6	8.0	8.0		5.6	5.6		4.2		
75.0	11.6	11.6	11.6	8.0	8.0		5.6	5.6		4.2	4.2	
80.0	11.6	11.6	11.6	8.0	8.0	8.0	5.6	5.6		4.2	4.2	
85.0	11.6	11.6	11.6	8.0	8.0	8.0	5.6	5.6		4.2	4.2	
90.0	10.6	10.6	11.6	8.0	8.0	8.0	5.6	5.6	5.6	4.2	4.2	4.0
95.0	9.4	9.4	10.4	8.0	8.0	8.0	5.6	5.6	5.6	4.2	4.2	4.0
100.0	8.2	8.2	9.2	8.0	8.0	8.0	5.6	5.6	5.6	4.2	4.2	4.0
105.0	7.2	7.2	8.2	7.8	7.8	8.0	5.6	5.6	5.6	4.2	4.2	4.0
110.0	6.2	6.2	7.2	6.8	6.8	8.0	5.6	5.6	5.6	4.2	4.2	4.0
115.0	5.4	5.4	6.2	6.0	6.0	7.6	5.6	5.6	5.6	4.2	4.2	4.0
120.0	4.6	4.6	5.4	5.2	5.2	6.8	5.0	5.0	5.6	4.2	4.2	4.0
125.0	3.8	3.8	4.6	4.6	4.6	6.0	4.2	4.2	5.6	4.0	4.0	4.0
130.0	3.2	3.2	4.0	3.8	3.8	5.2	3.6	3.6	5.0	3.4	3.4	4.0
135.0	2.6	2.6	3.2	3.2	3.2	4.4	3.0	3.0	4.2	2.8	2.8	4.0
140.0	2.0	2.0	2.6	2.6	2.6	3.8	2.4	2.4	3.6	2.2	2.2	3.6
145.0			2.0	2.2	2.2	3.2	2.0	2.0	3.0			3.0
150.0						2.6			2.6			2.4
155.0						2.2			2.0			

Loads for luffing

60 m
(197 ft)11-18-26-32 m m
(36-59-85-105 ft)21 000 kg
(46,200 lb)25.6 ft x 24.6 ft spread
100%

360°



Pounds x 1000

Feet	197' + 36'		197' + 59'		197' + 85'		197' + 105'	
	0°-20°	20°-40°	0°-20°	20°-40°	0°-20°	20°-40°	0°-20°	20°-40°
40.0								
45.0								
50.0	11.2							
55.0	11.2	11.2						
60.0	11.2	11.2	7.2					
65.0	11.2	11.2	7.2					
70.0	11.2	11.2	7.2					
75.0	11.2	11.2	7.2		5.6			
80.0	11.2	11.2	7.2	7.2	5.6		4.2	
85.0	11.2	11.2	7.2	7.2	5.6		4.2	
90.0	10.6	11.2	7.2	7.2	5.6	5.6	4.2	3.8
95.0	9.4	10.4	7.2	7.2	5.6	5.6	4.2	3.8
100.0	8.2	9.2	7.2	7.2	5.6	5.6	4.2	3.8
105.0	7.2	8.2	7.2	7.2	5.6	5.6	4.2	3.8
110.0	6.2	7.2	6.8	7.2	5.6	5.6	4.2	3.8
115.0	5.4	6.2	6.0	7.2	5.6	5.6	4.2	3.8
120.0	4.6	5.4	5.2	6.8	5.0	5.6	4.2	3.8
125.0	3.8	4.6	4.6	6.0	4.2	5.6	4.0	3.8
130.0	3.2	4.0	3.8	5.2	3.6	5.0	3.4	3.8
135.0	2.6	3.2	3.2	4.4	3.0	4.2	2.8	3.8
140.0	2.0	2.6	2.6	3.8	2.4	3.6	2.2	3.6
145.0		2.0	2.2	3.2	2.0	3.0		3.0
150.0				2.6		2.6		2.4
155.0				2.2		2.0		

THIS CHART IS ONLY A GUIDE AND SHOULD NOT BE USED TO OPERATE THE CRANE.

Grove GMK5165-2 The individual crane's load chart, operating instructions and other instructional plates must be read and understood prior to operating the crane



Working range

42 ft - 197 ft main boom with 12 ft integrated heavy duty jib

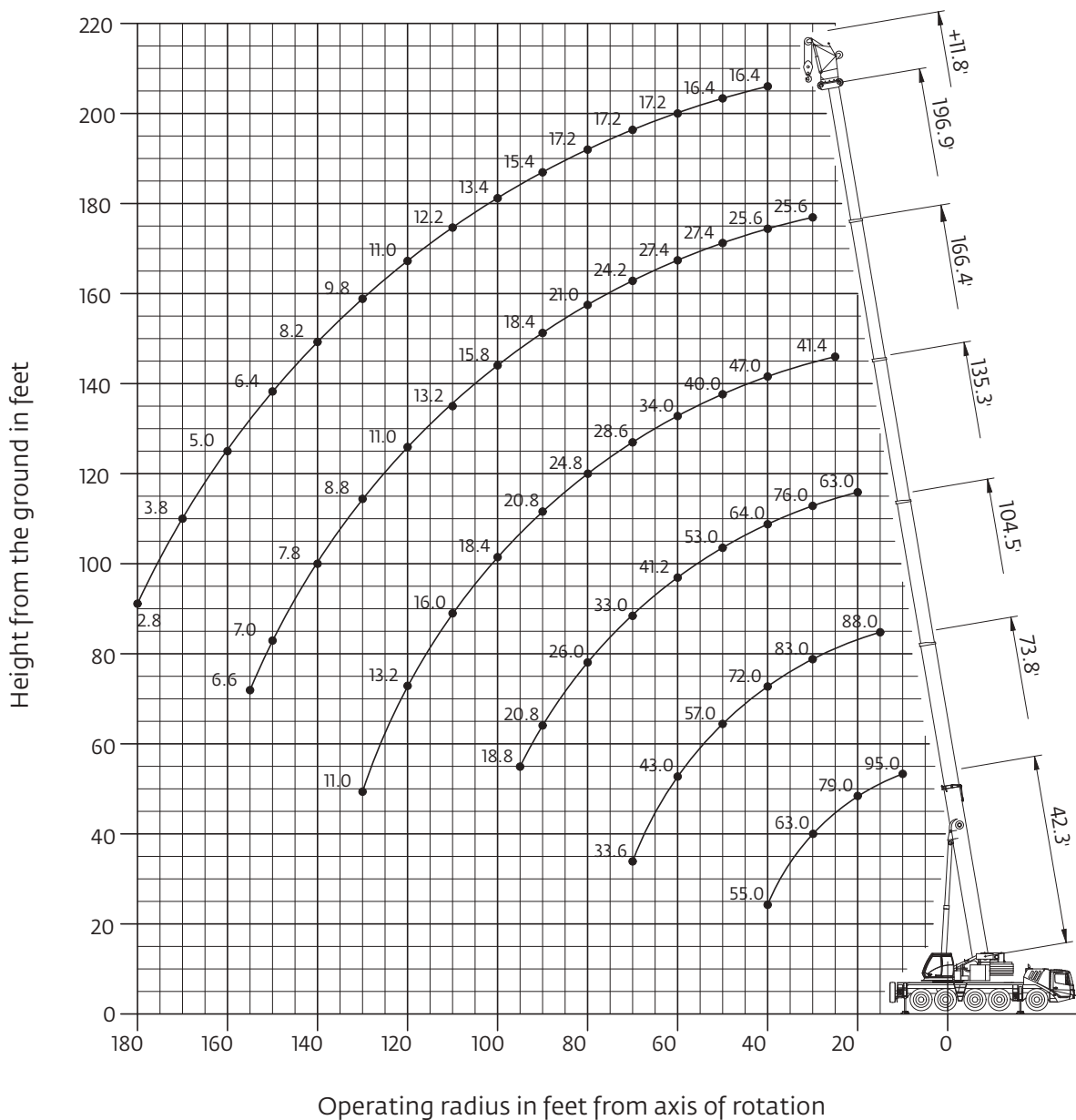

Hook heights shown in the working range diagram do not consider loaded boom deflection.

THIS CHART IS ONLY A GUIDE AND SHOULD NOT BE USED TO OPERATE THE CRANE.

The individual crane's load chart, operating instructions and other instructional plates must be read and understood prior to operating the crane.



Load charts

Integrated heavy duty jib

Intermediate angle

12,9 m - 60,0 m
(42.3 - 196.9 ft)3,6 m
(11.8 ft)40 100 kg
(88,400 lb)25.6 ft x 24.6 ft spread
100%

360°



Pounds x 1000

Feet	42.3' + 11.8'			73.8' + 11.8'			104.5' + 11.8'			135.3' + 11.8'			166.4' + 11.8'			196.9' + 11.8'		
	0°	<20°	<40°	0°	<20°	<40°	0°	<20°	<40°	0°	<20°	<40°	0°	<20°	<40°	0°	<20°	<40°
10.0	95.0	95.0	88.0															
15.0	91.0	87.0	85.0			88.0												
20.0	79.0	78.0	78.0	95.0	93.0	88.0			63.0									
25.0	70.0	70.0	71.0	91.0	87.0	85.0			63.0			41.4						
30.0	63.0	63.0		83.0	81.0	81.0	76.0	66.0	63.0			41.4			25.6			
35.0	59.0	59.0		76.0	76.0	76.0	70.0	66.0	63.0			41.4			25.6			
40.0	55.0			71.0	71.0	72.0	64.0	64.0	63.0	47.0	41.4	41.4			25.6			16.4
45.0				64.0	64.0	64.0	59.0	59.0	59.0	43.2	41.4	41.4	27.4	25.6	25.6			16.4
50.0				57.0	57.0	57.0	53.0	53.0	53.0	40.0	39.8	39.8	27.4	25.6	25.6			16.4
55.0				49.0	49.0		46.0	46.0	47.0	36.8	36.8	37.0	27.4	25.6	25.6		17.2	16.4
60.0				43.0	43.0		41.0	41.0	41.2	34.0	34.0	34.0	27.4	25.6	25.6		17.2	16.4
65.0					37.8		36.6	36.6	36.8	30.8	30.8	31.0	25.8	25.4	25.4		17.2	16.4
70.0						33.6	32.8	32.8	33.0	28.6	28.6	28.6	24.2	24.2	24.2		17.2	16.4
75.0							29.4	29.4	29.4	26.4	26.4	26.6	22.6	22.6	22.6		17.2	16.4
80.0							26.0	26.0		24.6	24.6	24.8	21.0	21.0	21.0		17.2	16.4
85.0							23.2	23.2		22.8	22.8	23.0	19.6	19.6	19.6		16.4	16.4
90.0							20.8	20.8		20.6	20.6	20.8	18.2	18.2	18.4		15.4	15.4
95.0								18.8	18.8		19.2	19.2	17.0	17.0	17.2		14.2	14.2
100.0										18.4	18.4		15.8	15.8	15.8		13.4	13.4
105.0										17.4	17.4		14.4	14.4	14.4		12.8	12.8
110.0										16.0	16.0		13.0	13.0	13.2		12.2	12.2
115.0										14.6	14.6		12.2	12.2	12.2		11.6	11.6
120.0										13.2	13.2		11.0	11.0			11.0	11.0
125.0										12.0			9.8	9.8			10.4	10.4
130.0										11.0			8.8	8.8			9.8	9.8
135.0													8.2	8.2			9.0	9.0
140.0													7.8	7.8			8.2	8.2
145.0													7.4	7.4			7.2	7.2
150.0													7.0	7.0			6.4	6.4
155.0													6.6				5.8	5.8
160.0																	5.0	5.0
165.0																	4.4	4.4
170.0																	3.8	3.8
175.0																	3.4	3.4
180.0																	2.8	

Loads for luffing

12,9 m - 60,0 m
(42.3 - 196.9 ft)3,6 m
(11.8 ft)40 100 kg
(88,400 lb)25.6 ft x 24.6 ft spread
100%

360°



Pounds x 1000

Feet	42.3' + 11.8'		73.8' + 11.8'		104.5' + 11.8'		135.3' + 11.8'		166.4' + 11.8'		196.9' + 11.8'	
	0°-20°	20°-40°	0°-20°	20°-40°	0°-20°	20°-40°	0°-20°	20°-40°	0°-20°	20°-40°	0°-20°	20°-40°
10.0	67.0	67.0										
15.0	64.0	64.0		67.0								
20.0	62.0	62.0	66.0	66.0		60.0						
25.0	58.0	60.0	64.0	64.0		60.0			39.4			
30.0	55.0		63.0	63.0	63.0	60.0			39.4		24.4	
35.0	53.0		62.0	62.0	63.0	60.0			39.4		24.4	
40.0			59.0	61.0	61.0	60.0		39.4	39.4		24.4	15.6
45.0			57.0	60.0	56.0	56.0	39.4	39.4	24.4	24.4		15.6
50.0			53.0	53.0	52.0	52.0	38.0	38.0	24.4	24.4		15.6
55.0			45.0		45.0	45.0	35.2	35.2	24.4	24.4		15.6
60.0			39.4		39.0	39.2	32.4	32.4	24.4	24.4		15.6
65.0			34.4		34.2	34.2	29.4	29.4	24.2	24.2		15.6
70.0					30.0	30.2	27.2	27.2	23.0	23.0		15.6
75.0					26.6	26.8	25.2	25.4	21.4	21.4		15.6
80.0					23.8		23.4	23.6	20.0	20.0		15.6
85.0					21.2		21.2	21.4	18.6	18.6		15.6
90.0					19.0		19.2	19.4	17.4	17.4		14.6
95.0					17.0		18.2		16.2	16.2		13.6
100.0							17.4		15.0	15.0		12.6
105.0							15.8		13.8	13.8		12.2
110.0							14.4		12.4	12.4		11.6
115.0							13.2		11.2	11.2		11.0
120.0							12.0		10.0			10.4
125.0									9.0			9.8
130.0									8.2			9.0
135.0									7.8			8.2
140.0									7.4			7.4
145.0									7.0			6.6
150.0									6.6			5.8
155.0												5.2
160.0												4.6
165.0												4.0
170.0												3.6
175.0												3.0

THIS CHART IS ONLY A GUIDE AND SHOULD NOT BE USED TO OPERATE THE CRANE.

Grove GMK5165-2 The individual crane's load chart, operating instructions and other instructional plates must be read and understood prior to operating the crane



Load charts

Integrated heavy duty jib

Intermediate angle

12,9 m - 60,0 m
(42.3 - 196.9 ft)3,6 m
(11.8 ft)46 200 kg
(21,000 lb)25.6 ft x 24.6 ft spread
100%

360°



Pounds x 1000

Feet	42.3' + 11.8'			73.8' + 11.8'			104.5' + 11.8'			135.3' + 11.8'			166.4' + 11.8'			196.9' + 11.8'		
	0°	<20°	<40°	0°	<20°	<40°	0°	<20°	<40°	0°	<20°	<40°	0°	<20°	<40°	0°	<20°	<40°
10.0	95.0	95.0	88.0															
15.0	91.0	87.0	85.0															
20.0	79.0	78.0	78.0	95.0	93.0	88.0			63.0									
25.0	70.0	70.0	71.0	91.0	87.0	85.0			63.0			41.4						
30.0	63.0	63.0		76.0	76.0	77.0	68.0	66.0	63.0			41.4			25.6			
35.0	59.0	59.0		62.0	62.0	63.0	56.0	56.0	57.0			41.4			25.6			
40.0	55.0			51.0	51.0	52.0	47.0	47.0	47.0			41.4			25.6			16.4
45.0				43.4	43.4	43.8	39.4	39.4	39.8	36.6	36.6	37.2	27.4	25.6	25.6			16.4
50.0				37.0	37.0	37.4	33.6	33.6	34.0	32.6	32.6	32.6	27.4	25.6	25.6			16.4
55.0				32.0	32.0		29.0	29.0	29.4	30.0	30.0	30.0	25.6	25.6	25.6		17.2	16.4
60.0				29.8	29.8		25.2	25.2	25.4	26.4	26.4	26.6	22.2	22.2	22.6		17.2	16.4
65.0				27.0	27.0		22.0	22.0	22.2	23.2	23.2	23.6	19.4	19.4	19.6		17.2	16.4
70.0				23.8			19.2	19.2	19.4	20.6	20.6	20.8	18.2	18.2	18.2		17.2	16.4
75.0							16.8	16.8	17.0	18.4	18.4	18.6	16.6	16.6	17.0		15.4	15.4
80.0							14.6	14.6		16.4	16.4	16.6	15.0	15.0	15.8		13.6	13.6
85.0							12.6	12.6		14.6	14.6	14.8	14.0	14.0	14.2		12.0	12.0
90.0							11.2	11.2		13.0	13.0	13.2	13.2	13.2	13.4		10.6	10.6
95.0							10.6	10.6		11.6	11.6		12.0	12.0	12.0		9.2	9.2
100.0										10.4	10.4		10.6	10.6	10.8		8.0	8.0
105.0										9.0	9.0		9.6	9.6	9.6		7.0	7.0
110.0										8.0	8.0		8.6	8.6	8.6		6.0	6.0
115.0										6.8	6.8		7.6	7.6	7.8		5.2	5.2
120.0										6.0	6.0		6.8	6.8			4.4	4.4
125.0										5.2			6.0	6.0			3.6	3.6
130.0										4.4			5.2	5.2			3.0	3.0
135.0													4.4	4.4			2.4	2.4
140.0													3.8	3.8				
145.0													3.2	3.2				
150.0													2.6	2.6				
155.0													2.0					

Loads for luffing

12,9 m - 60,0 m
(42.3 - 196.9 ft)3,6 m
(11.8 ft)46 200 kg
(21,000 lb)25.6 ft x 24.6 ft spread
100%

360°



































Pounds x 1000

Feet	42.3' + 11.8'		73.8' + 11.8'		104.5' + 11.8'		135.3' + 11.8'		166.4' + 11.8'		196.9' + 11.8'	
	0°-20°	20°-40°	0°-20°	20°-40°	0°-20°	20°-40°	0°-20°	20°-40°	0°-20°	20°-40°	0°-20°	20°-40°
10.0	67.0	67.0										
15.0	64.0	64.0		67.0								
20.0	62.0	62.0	66.0	66.0			60.0					
25.0	58.0	60.0	64.0	64.0			60.0			39.4		
30.0	55.0		63.0	63.0	63.0	60.0			39.4		24.4	
35.0	53.0		62.0	62.0	56.0	57.0			39.4		24.4	
40.0			51.0	51.0	47.0	47.0	39.4	39.4			24.4	
45.0			41.6	42.0	39.4	39.8	36.6	37.2	24.4	24.4		15.6
50.0			34.6	34.8	33.6	34.0	31.4	31.8	24.4	24.4		15.6
55.0			30.4		28.8	29.2	28.6	28.6	24.4	24.4		15.6
60.0			28.2		24.4	24.6	26.4	26.6	22.2	22.6	15.6	15.6
65.0			24.6		21.0	21.0	23.2	23.6	19.4	19.6	15.6	15.6
70.0					18.0	18.0	20.4	20.6	17.2	17.2	15.6	15.6
75.0					15.4	15.6	17.8	18.0	15.8	16.2	15.4	15.6
80.0					13.4		15.6	15.8	14.2	15.0	13.6	13.8
85.0					11.4		13.8	13.8	13.4	13.6	12.0	12.2
90.0					10.6		12.2	12.2	12.6	12.8	10.6	10.6
95.0					10.0		10.6		11.6	11.6	9.2	9.4
100.0							9.4		10.2	10.4	8.0	8.2
105.0							8.2		9.0	9.2	7.0	7.2
110.0							7.2		8.0	8.0	6.0	6.2
115.0							6.2		7.0	7.2	5.4	5.2
120.0							5.4		6.2		4.4	4.4
125.0									5.4		3.6	3.8
130.0									4.8		3.0	3.0
135.0									4.0		2.4	2.4
140.0									3.4			
145.0									2.8			
150.0									2.4			



Symbols glossary

 Axles	 Counterweight	 Grade	 Radius
 Boom	 Drive	 Hoist	 Rotation
 Boom elevation	 Electrical system	 Hookblock	 Speed
 Boom extension	 Engine	 Hydraulic system	 Steering
 Boom length	 Extension	 Lights	 Suspension
 Boom nose	 Frame	 Oil	 Swing
 Brakes	 Fuel tank capacity	 Outrigger controls	 Tires
 Cab	 Gear	 Outriggers	 Transmission



Regional headquarters

Manitowoc - Americas

Manitowoc, Wisconsin, USA

Tel: +1 920 684 6621

Fax: +1 920 683 6277

Shady Grove, Pennsylvania, USA

Tel: +1 717 597 8121

Fax: +1 717 597 4062

Manitowoc - Europe, Middle East & Africa

Ecully, France

Tel: +33 (0)4 72 18 20 20

Fax: +33 (0)4 72 18 20 00

Manitowoc - Asia Pacific

Shanghai, China

Tel: +86 21 6457 0066

Fax: +86 21 6457 4955

Regional offices

Americas

Brazil

Alphaville

Mexico

Monterrey

Chile

Santiago

Europe, Middle East & Africa

Czech Republic

Netvorice

France

Baudemont

Cergy

Decines

Germany

Langenfeld

Hungary

Budapest

Italy

Parabiago

Netherlands

Breda

Poland

Warsaw

Portugal

Baltar

Russia

Moscow

U.A.E.

Dubai

U.K.

Gawcott

Asia - Pacific

Australia

Brisbane

Melbourne

Sydney

China

Beijing

Xi'an

India

Hyderabad

Pune

Korea

Seoul

Philippines

Makati City

Singapore

Factories

Brazil

Alphaville

China

TaiAn

Zhangjiagang

France

Charlieu

La Clayette

Moulines

Germany

Wilhelmshaven

India

Pune

Italy

Niella Tanaro

Portugal

Baltar

Fânzeres

Slovakia

Saris

USA

Manitowoc

Port Washington

Shady Grove

This document is non-contractual. Constant improvement and engineering progress make it necessary that we reserve the right to make specification, equipment, and price changes without notice. Illustrations shown may include optional equipment and accessories and may not include all standard equipment.