

# TEREX T 300 SERIES

truck cranes  
specifications

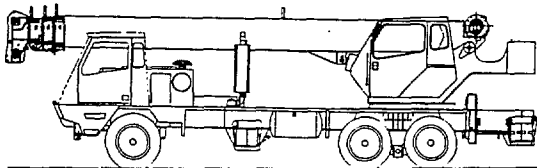

---

## STANDARD BOOM EQUIPMENT

### BOOM

30-94 ft. (9.23-28.49 m), four section full power mechanically synchronized boom. Boom is high strength four plate design, welded inside and out, with anti-friction slide pads. Boom side plates are made with stamped impressions to reduce weight and increase strength. A single boom hoist cylinder provides for boom elevation of -4 to 77 degrees. Maximum tip height is 99 ft. (30.17 m).

### BOOM HEAD

Welded to outer section of boom. Four or five load sheaves and two idler sheaves mounted on heavy duty, anti-friction bearings. Quick reeving boom head. Provisions made for side-stow jib mounting.

---

## OPTIONAL BOOM EQUIPMENT

### MAIN BOOM

33-81 ft. (10.15 - 24.83 m), three section full power, mechanically synchronized boom. Boom is high strength four plate design, welded inside and out, with anti-friction slide pads. Boom side plates are made with stamped impressions to reduce weight and increase strength. A single boom hoist cylinder provides for boom elevation of -4 to 77 degrees. Maximum tip height is 87 ft. (26.52 m).

### JIBS

32 ft. (9.68 m) side stow swing-on one-piece lattice type jib. Single sheave mounted on anti-friction bearing. Jib is offsettable at 0°, 15°, or 30°. Maximum tip height is 129 ft. (39.32 m) with 94 ft. (28.49 m) boom.

32-49 ft. (9.68 -14.86 m) side-stow swing-on lattice type jib. Single sheave mounted on anti-friction bearing. Jib is extendible to 49 ft. (14.86 m) by means of a 17 ft. (5.18 m)

manual pull-out tip section, roller supported for ease of extension. Jib is offsettable at 0°, 15°, or 30°. Maximum tip height is 147 ft. (44.81 m) with 94 ft. (28.49 m) boom.

### AUXILIARY BOOM HEAD

Removable auxiliary boom head has single sheave mounted on anti-friction bearing. Removable pin-type rope guard for quick reeving. Installs on main boom peak only. Removal is not required for jib use.

### HOOK BLOCK

Three or four metallic sheaves on anti-friction bearings with hook and heavy duty hook latch. Quick reeving design does not require removal of wedge and socket from rope.

### HOOK & BALL

7 ton (6.3 mt) top swivel ball with hook and hook latch.

# STANDARD UPPERSTRUCTURE EQUIPMENT

## UPPERSTRUCTURE FRAME

All welded one-piece structure fabricated with high tensile strength alloy steel. Counterweight is bolted to frame.

## TURNTABLE CONNECTION

Swing bearing is a single row, ball type, with external teeth. The swing bearing is bolted to the revolving upperstructure and to the carrier frame.

## SWING

A hydraulic motor drives a double planetary reduction gear for precise and smooth swing function. Maximum swing speed (no load) is 2.8 rpm.

## SWING BRAKE

Heavy duty multiple disc swing brake is mechanically actuated from operator's cab by foot pedal. Brake may be locked on or used as a momentary brake.

## RATED CAPACITY INDICATOR

Built in Rated Capacity Indicator with visual and audible warning system and automatic function disconnects. Pictographic display includes: boom radius, boom angle, boom length, allowable load, actual load, and percentage of allowable load registered by bar graph. Operator settable alarms provided for swing angle, boom length, boom angle, tip height and work area exclusion zone. Anti-two block system includes audio/visual warning and automatic function disconnects.

## OPERATOR'S CAB

Environmental cab with all steel construction, optimum visibility, tinted safety glass throughout, and rubber floor matting is mounted on vibration absorbing pads. The cab has a sliding door on the left side, framed sliding window on the right side, hinged tinted all glass skylight and removable front windshield to provide optimum visibility of the load open or closed. Acoustical foam padding insulates against sound and weather. The deluxe six-way adjustable operator's seat is equipped with a torsion bar suspension and includes head and arm rests.

# STANDARD CARRIER EQUIPMENT

## CARRIER CHASSIS

Chassis is Lorain designed and built with a 6 x 4 drive. Triple box construction frame is fabricated from high strength alloy steel and provides superior frame rigidity. Full aluminum decking reduces weight. Aluminum engine housing with sliding cover optimizes engine access while reducing weight and improving corrosion resistance.

## AXLES AND SUSPENSION

Rear axle - 40,000 lb. (18,144 kg) capacity tandem axles with heat treated housings have interaxle differential with lockout. Axles are mounted on equalizer beams to distribute weight evenly.

Front axle - I beam type axle is heavy duty multi-leaf spring-mounted with shock absorbers.

## TIRES

Front: Two 425/65R22.5-18 P.R. All-Position type tubeless.

Rear: Eight 11R22.5-14 P.R. transport type.

## BRAKES

Full air brakes on all wheels with split circuit system.

Front brakes: 16.5 x 6 in. (419 x 152 mm)

Rear brakes: 16.5 x 7 in. (419 x 178 mm).

All brakes are air operated "S" cam type with automatic slack adjusters. Lining areas are 384 in<sup>2</sup> (2477 cm<sup>2</sup>) front and 920 in<sup>2</sup> (5935 cm<sup>2</sup>) rear. Air compressor has standard air dryer. Rear tandem axles have spring-set, air-released parking or emer-

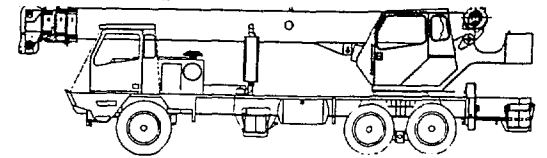

## CONTROLS

All control levers and pedals are positioned for efficient operation. Hand operated control levers include swing, boom telescope, boom hoist, winch(s), vernier adjustable hand throttle, and a two position house lock. Switches include ignition, engine stop, two-speed winch(s), lights, windshield wipers, defroster, outriggers, etc. Horn and additional winch momentary shift switches are mounted in the levers. Foot control pedals include swing brake, boom raise, boom lower, service brakes and throttle.

## INSTRUMENTATION AND ACCESSORIES

In-cab gauges include bubble level, engine oil pressure, fuel, engine temperature, and voltmeter. Indicators include high coolant temperature/low engine oil pressure audio/visual warning, low coolant level audio/visual warning, and Rated Capacity Indicator. Accessories include fire extinguisher, windshield washer/wiper, skylight wiper, L.H. rear view mirror, dash and dome lights, and seat belt. Circuit breakers protect electrical circuits.

## HYDRAULIC CONTROL VALVES

Valves are mounted on the rear of the upperstructure and are easily accessible. Valves are mechanically operated and include one three spool valve for boom elevation, telescope, main winch; one single spool valve for swing; and one single spool valve for future installation of an auxiliary winch. High pressure regeneration feature provides 2-speed boom extension. Quick disconnects are provided for ease of installation of pressure check gauges.

## OPTIONAL EQUIPMENT

Auxiliary Winch • 360° House Lock • LP Heater/Defroster • Hydraulically Powered Air Conditioner • Diesel Heater/Defroster • Tachometer • Work Lights • Outrigger Controls on Sides of Carrier • Heavy Counterweight Package

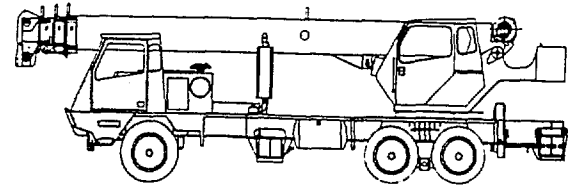

gency brake chambers. Parking brake is applied with valve mounted on dash panel. Emergency brakes apply automatically when air pressure drops below 60 psi (4.2 kg/cm<sup>2</sup>).

## STEERING

Mechanism includes rack and pinion with integral hydraulic power.

	To $\odot$ of tires	To corner of carrier
Turning radius	34' 0" (10.35 m)	37' 7" (11.46 m)

## TRANSMISSION

Standard: Fuller transmission has 10 speeds forward and 3 reverse, with neutral safety start. Gear selection is accomplished by single level shift control and two position air shift range selector. Optional: Allison MD3560 provides 6 speeds forward with lock-up in top 5 gears. Adaptive feed back controls continually optimize shifts for weight, terrain, etc..

## MULTI-POSITION OUT & DOWN OUTRIGGERS

Fully independent hydraulic outriggers may be utilized fully extended to 20 ft. (6.10 m), in their 1/2 extended position, or fully retracted. Removable aluminum outrigger pads are 452 in<sup>2</sup> (2919 cm<sup>2</sup>) and stow on the carrier frame. Complete controls and sight leveling bubble are located in the operator's cab. Includes 5th, front outrigger.

# STANDARD CARRIER EQUIPMENT (continued)

## CARRIER CAB

One-man aluminum cab is mounted on vibration absorbing pads and has optimum visibility, safety glass, acoustical foam padding inside cab for insulating against sound and weather, six-way adjustable torsion bar suspension seat with seat belt and lockable door with roll down window.

## CONTROLS

Included are transmission shift, inter-axle differential lock, parking brake, two-speed windshield wiper/washer, heater and defroster, lights, headlight dimmer, dome light, and ignition switch.

## INSTRUMENTS

Included are speedometer, hour meter, tachometer, voltmeter, fuel gauge, engine oil pressure gauge, water temperature gauge, dual air pressure gauges. Warning lights include low coolant level, parking brakes on, low air, pumps engaged, and high beam lights.

## HYDRAULIC SYSTEM

### HYDRAULIC PUMPS

Triple pump driven from engine flywheel housing PTO with air shifted mechanical pump disconnect at 1.15 times engine speed. A separate steering pump is driven directly from the engine. Combined system capacity is 115 gpm (435 lpm). Hydraulic oil cooler is standard.

#### Main Winch Pump

54 gpm (204.4 lpm) @ 3,500 psi (246.1 kg/cm<sup>2</sup>)

#### Boom Hoist and Telescope Pump

39 gpm (147.6 lpm) @ 3,500 psi (246.1 kg/cm<sup>2</sup>)

#### Outrigger and Swing Pump

22 gpm (83.3 lpm) @ 2,500 psi (175 kg/cm<sup>2</sup>)

## MAIN WINCH SPECIFICATIONS

Hydraulic winch with bent axis piston motor and planetary reduction gearing provides 2-speed operation with equal speeds for power up and down. Winch is equipped with an integral automatic brake, grooved drum, tapered flanges, standard cable roller on drum, and electronic rotation indicator.

### PERFORMANCE

Max. line speed (no load)

First layer 167 fpm (50.9 m/min)

Fifth layer 242 fpm (73.8 m/min)

Max. line pull-first layer 15,639 lbs (7 093 kg)

Max. line pull-fifth layer 10,827 lbs (4 911 kg)

Permissible line pull 9,000 lbs (4082 kg)

### LO-RANGE

### HI-RANGE

335 fpm (102.1 m/min)

484 fpm (147.5 m/min)

7,298 lbs (3 310 kg)

5,052 lbs (2 291 kg)

### DRUM DIMENSIONS

10.62 in (270 mm) drum diameter

17.55 in (446 mm) length

18.0 in (457 mm) flange dia.

Cable: 5/8" x 450 ft. (16 mm x 137.2 m) height above

Cable type: 5/8" (16 mm) 6x19 IWRC IPS right regular lay, preformed. Min.

breaking strength 17.9 tons (16.2 mt).

### DRUM CAPACITY

Max. Storage: 570 ft (173.7 m)

6th layer not a working layer

Max. Usable: 455 ft. (138.7 m)\*

\*Based on minimum flange top layer to comply with

ANSI B30.5

## ACCESSORIES

Included are fire extinguisher, right hand and left hand rear view mirrors, electric horn, access steps and grab handles (located at four separate points around the crane), back-up alarm, two position boom rack, front and rear towing loops.

## LIGHTS

Light package includes headlights with foot operated dimmer switch, clearance lights, tail lights, directional signal lights, four-way hazard flasher lights, back-up lights with audible alarm.

## OPTIONAL EQUIPMENT

Spare Tire with Wheel • Immersion Heater(s) • Pintle Hook • Cold Weather Kit • Allison MD 356AA8.3 6 speed Automatic Transmission with 300 HP Cummins ISC-285 Diesel Engine • Air Suspension for Drivers Seat • Front and/or Rear Air Suspension • Aluminum R/L Hand Tool Boxes

### Power Steering Pump

8 gpm (30.3 lpm) @ 1500 psi (105.5 kg/cm<sup>2</sup>)

## FILTRATION

Full flow oil filtration system with bypass protection includes a removable 60 mesh (250 micron) suction screen-type filter and 5 micron replaceable return line filter.

## HYDRAULIC RESERVOIR

All welded construction with internal baffles and diffuser. Provides easy access to filters and is equipped with an external sight level gauge. The hydraulic tank is pressurized to aid in keeping out contaminants and in reducing potential pump cavitation. Capacity is 91 gal (344 liters).

## OPTIONAL AUX. WINCH

Hydraulic 2-speed winch with bent axis piston motor, equal speed power up and down, planetary reduction with integral automatic brake, grooved drum with tapered flanges, drum roller, and rotation indicator.

### PERFORMANCE

Max. line speed (no load)

Fifth layer 484 fpm (147.5 m/min)

Max. line pull

First layer 15,639 lbs (7 093 kg)

### DRUM DIMENSIONS

AND CAPACITY (Same as main winch)

## OPTIONAL HOIST LINE

MAIN WINCH AND OPTIONAL AUXILIARY WINCH - 5/8" (16 mm) rotation resistant compacted strand 18 x 19 or 19 x 19. Min breaking strength 22.6 tons (20.6 mt).

## ENGINE SPECIFICATIONS

Make and Model	Cummins ISC-285
Type	6 cylinder
Bore and Stroke	4.49 x 5.32 in. (114 x 135 mm)
Displacement	504.5 cu. in. (8.27 l)
Max. Gross Horsepower	300 hp 224 kw) @ 2000 rpm
Max. Gross Torque	860 lbs•ft (111 kg•m)/1300 rpm
Net Horsepower	242 hp (180 kw) @ 2000 rpm
Aspiration	turbocharged
Electrical System	12 volt
Alternator	100 amp
Battery	(2) 12V-1600 C.C.A. @ 0°F (18°C)
Fuel Capacity	60 gal (227 l)

## SPEED AND GRADEABILITY

ENGINE TRANSMISSION	SPEED RANGE	GRADEABILITY
Cummins Manual	60 mph (96 km/h)	56%
Cummins Automatic	60 mph (96 km/h)	64%

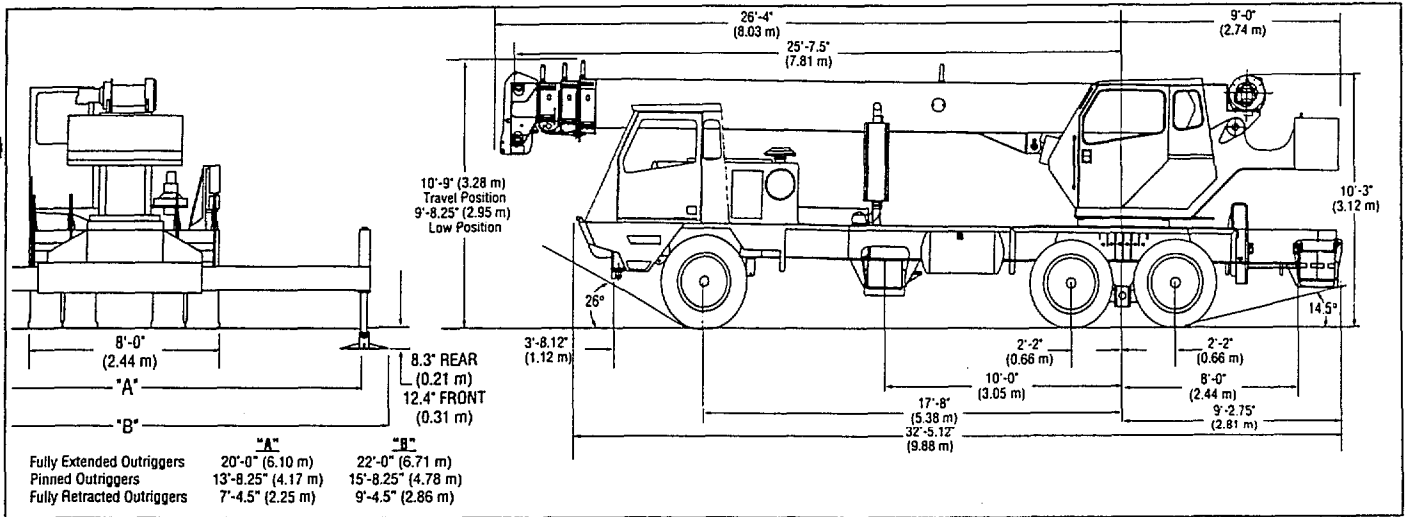

WEIGHTS & AXLE LOADS	GROSS WEIGHT LBS.	UPPER IN TRAVEL POSITION		GROSS WEIGHT KG.	UPPER IN TRAVEL POSITION	
		FRONT	REAR		FRONT	REAR
Basic Crane with ISC-285, Engine, 94' (28.49 m) Boom, 2,000 + 500 lb. (1633 + 227 kg) Cwt., 1/4 Tank of Fuel, 425/65Rx22.5 18 PR Front and 11R22.5 14 PR Rear Tires with Disc Wheels, and 200 lb. (90.7 kg) Operator in Cab.	47,213	16,454	30,759	21,415	7,463	13,952
<b>Add Options:</b>						
32' (9.68 m) Swing-on Jib on 94' (28.49 m) Boom	+ 1,368	+ 797	+ 571	+ 620	+ 362	+ 258
32' (9.68 m) Swing-on Jib on 81' (24.83 m) Boom	+ 1,368	+ 1,030	+ 338	+ 620	+ 467	+ 153
32'-49' (9.68-14.86 m) Swing on Jib on 94' (28.49 m) Boom	+ 1,789	+ 1,004	+ 785	+ 811	+ 455	+ 356
32'-49' (9.68-14.86 m) Swing on Jib on 81' (24.83 m) Boom	+ 1,789	+ 1,307	+ 482	+ 811	+ 593	+ 218
Auxiliary Boom Head on 94' (28.49 m) Boom	+ 100	+ 180	- 80	+ 45	+ 82	- 37
Auxiliary Boom Head on 81' (24.83 m) Boom	+ 100	+ 197	- 97	+ 45	+ 89	- 44
Full Tank of Fuel	+ 315	+ 120	+ 195	+ 142	+ 54	+ 88
Auxiliary Winch W/Drum Roller and Wire Rope	+ 175	- 73	+ 248	+ 79	- 112	+ 191
Heater/Defroster (Upper)	+ 60	- 5	+ 65	+ 27	- 2	+ 25
Work Lights	+ 35	+ 5	+ 30	+ 16	+ 2	+ 18
Pintle Hook (Rear)	+ 50	- 26	+ 76	+ 23	- 12	+ 34
Electric Remote Control	+ 200	+ 100	+ 100	+ 91	+ 45	+ 45
40 ton (36.3 mt) Quick Reeving Hook Block (On Bumper - 4 Sheave)	+ 690	+ 973	- 283	+ 313	+ 441	- 128
30 ton (27.2 mt) Quick Reeving Hook Block (On Bumper - 3 Sheave)	+ 670	+ 945	- 275	+ 304	+ 429	- 125
25 ton (22.7 mt) Quick Reeving Hook Block (On Bumper - 2 Sheave)	+ 682	+ 962	- 280	+ 309	+ 436	- 127
7 ton (6.3 mt) Hook and Ball (At boom rack)	+ 240	+ 145	+ 95	+ 109	+ 66	+ 43
<b>Substitute:</b>						
33-81' (10.15-24.83m) Boom w/3,100 lb (1,406 kg) upper Cwt. & 500 lb (227 kg) F. Bumper	- 640	- 630	10	- 290	- 286	4
7,200 lb Upper Cwt w/1,850 F. Bumper (94' Boom)	+ 6,636	- 619	+ 7,255	+ 3010	- 281	+ 3291
7,200 lb Upper Cwt w/1,850 F. Bumper (81' Boom)	+ 5,450	- 121	+ 5,571	+ 2472	- 55	+ 2527
Aux. Winch W/Drum Roller for Heavy Cwt. (above)	+ 5	+ 5	+ 0	+ 2	+ 2	+ 0
Add for Spin Resistant Wire Rope (per winch)	+ 32	- 12	+ 44	+ 14	- 6	+ 20
360° Mechanical house Lock	+ 85	0	+ 85	+ 39	0	+ 39
Aluminum Disc Wheels (Std Tires)	- 366	- 134	- 232	- 166	- 61	- 105
Automatic Transmission	0	0	0	0	0	0
Automatic Transmission w/2-spd Aux & 2 -spd Axles	+ 510	+ 300	+ 210	+ 231	+ 136	+ 95

NOTE: Weights are for Lorain supplied equipment and subject to 2% variation due to manufacturing tolerances. WE RESERVE THE RIGHT TO AMEND THESE SPECIFICATIONS AT ANY TIME WITHOUT NOTICE. THE ONLY WARRANTY APPLICABLE IS OUR STANDARD WRITTEN WARRANTY APPLICABLE TO THE PARTICULAR PRODUCT AND SALE. WE MAKE NO OTHER WARRANTY, EXPRESSED OR IMPLIED.

**TEREX CRANES**  
Waverly, Iowa

TEREX CRANES, INC.  
106 12th Street S.E. • Waverly, IA 50677-9466 USA  
(319) 352-3920 • FAX: (319) 352-5727

# TEREX T 340

truck crane  
40 ton capacity

range diagram & lifting capacities

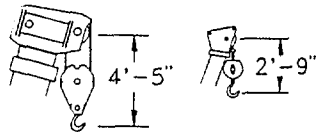

DIMENSIONS ARE FOR  
LARGEST FACTORY  
FURNISHED HOOK BLOCK  
AND HOOK & BALL,  
WITH ANTI-TWO BLOCK  
ACTIVATED

Range  
Diagram  
(30' - 94' boom)

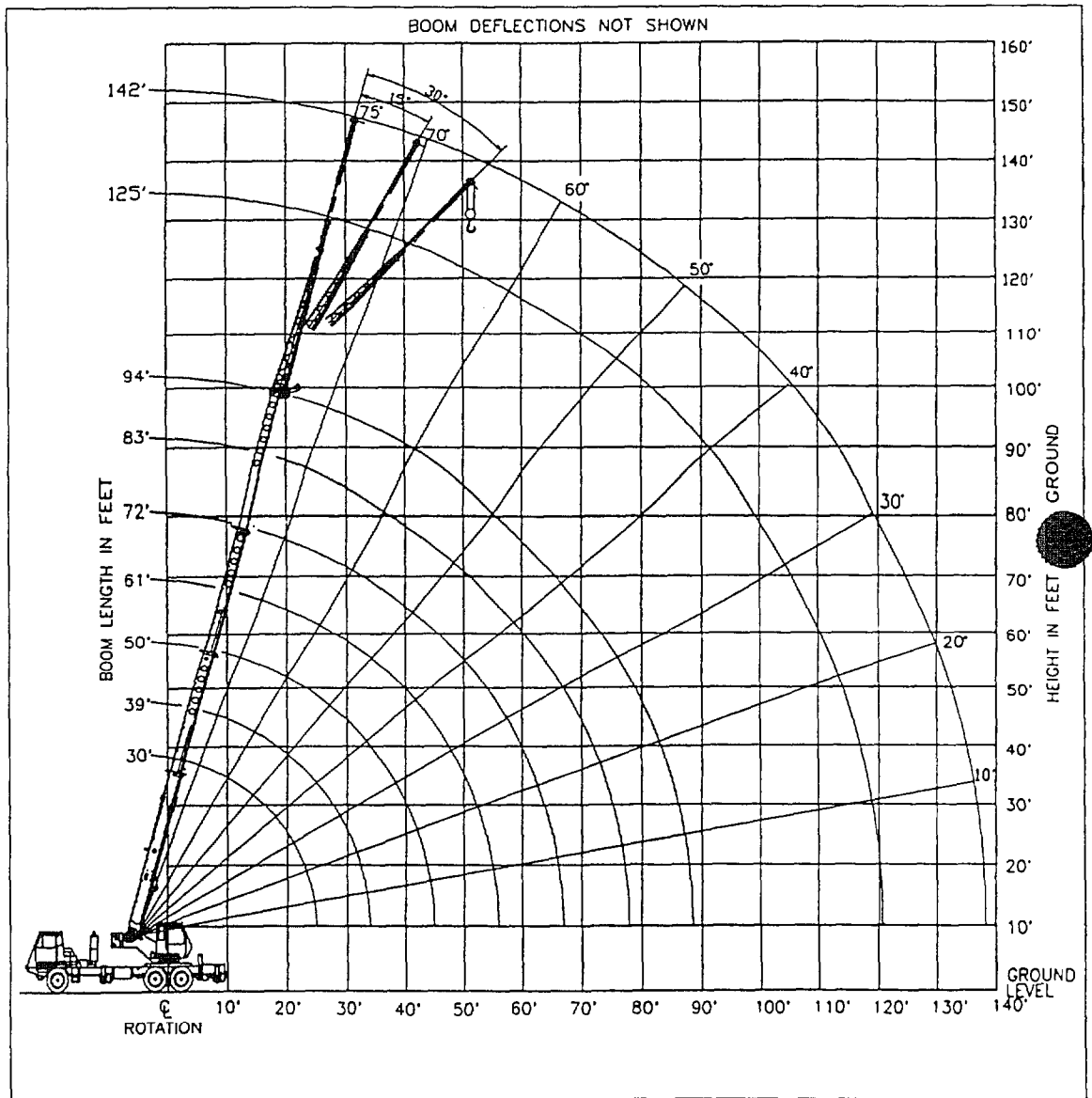

## CRANE WORKING CONDITIONS

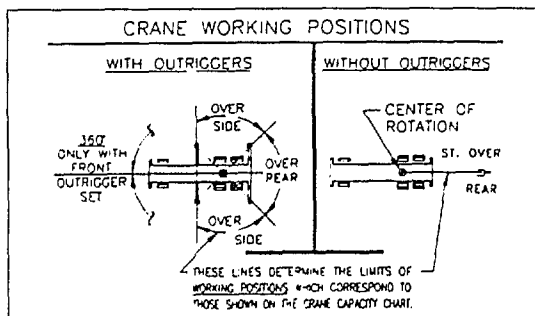

## REDUCTION IN MAIN BOOM CAPACITY

All Jibs in Stowed Position \_\_\_\_\_ 0 Lbs.  
Aux. Boom in Head Sheave \_\_\_\_\_ 100 Lbs.

## HOOK BLOCK WEIGHTS

Hook & Ball \_\_\_\_\_ 239 Lbs.  
25T Hook Block (2 Sheave) \_\_\_\_\_ 682 Lbs.  
30T Hook Block (3 Sheave) \_\_\_\_\_ 670 Lbs.  
40T Hook Block (4 Sheave) \_\_\_\_\_ 690 Lbs.

# Lifting Capacities – Pounds (30'– 94' boom and heavy-lift package)

## MODEL T 340

COUNTERWEIGHT:  
F. BUMPER 1850 LBS.  
UPPERSTRUCTURE:  
W/AUX. WINCH 6100 LBS.  
W/O AUX. WINCH 7200 LBS

BOOM LENGTH 30-94 FT.  
STABILITY PERCENTAGE  
ON OUTRIGGERS 85%  
ON TIRES 75%  
PCSA CLASS 9-118

**CAUTION:** Do not use this specification sheet as a load rating chart. The format of data is not consistent with the machine chart and may be subject to change.

### ON OUTRIGGERS - FULLY EXTENDED

LOAD RADIUS (FT)	BOOM LENGTH 30 FT			BOOM LENGTH 39 FT			BOOM LENGTH 50 FT			LOAD RADIUS (FT)
	LOADED BOOM ANGLE (DEG)	OVER REAR (LB)	360° (LB)	LOADED BOOM ANGLE (DEG)	OVER REAR (LB)	360° (LB)	LOADED BOOM ANGLE (DEG)	OVER REAR (LB)	360° (LB)	
9	65.1	80,000*	80,000*							9
10	63.0	70,100*	70,100*	69.4	46,600*	46,600*				10
12	58.5	61,000*	61,000*	66.2	46,600*	46,600*	71.7	46,600*	46,600*	12
15	51.4	49,400*	49,400*	61.2	46,600*	46,600*	68.0	44,300*	44,300*	15
20	37.4	35,300*	35,300*	52.3	36,100*	36,100*	61.6	36,600*	36,600*	20
25	13.7	26,700*	26,700*	42.0	27,600*	27,600*	54.8	28,100*	28,100*	25
30	**			28.8	21,900*	19,900	47.3	22,400*	20,400	30
35				**			38.7	17,900	15,300	35
40							27.9	14,300	11,800	40
45							7.9	11,500	9,300	45
50							**			50
55										55
60										60
65										65
70										70
75										75
80										80
85										85
90										90

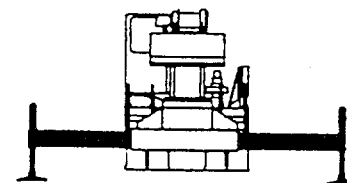

**USE THESE CHARTS ONLY  
WHEN ALL OUTRIGGERS  
ARE FULLY EXTENDED**

### ON OUTRIGGERS - FULLY EXTENDED

LOAD RADIUS (FT)	BOOM LENGTH 61 FT			BOOM LENGTH 72 FT			BOOM LENGTH 83 FT			BOOM LENGTH 94 FT			LOAD RADIUS (FT)
	LOADED BOOM ANGLE (DEG)	OVER REAR (LB)	360° (LB)	LOADED BOOM ANGLE (DEG)	OVER REAR (LB)	360° (LB)	LOADED BOOM ANGLE (DEG)	OVER REAR (LB)	360° (LB)	LOADED BOOM ANGLE (DEG)	OVER REAR (LB)	360° (LB)	
9													9
10													10
12													12
15	72.1	38,100*	38,100*										15
20	67.1	33,000*	33,000*	70.8	27,400*	27,400*							20
25	61.9	27,900*	27,900*	66.5	23,100*	23,100*	69.8	21,800*	21,800*	72.2	17,500*	17,500*	25
30	56.3	22,800*	20,700	62.0	19,900*	19,900*	66.0	18,300*	18,300*	69.0	15,000*	15,000*	30
35	50.4	18,200	15,600	57.4	17,400*	15,800	62.2	15,900*	15,900*	65.7	13,100*	13,100*	35
40	43.9	14,600	12,200	52.5	14,700	12,300	58.1	13,800*	12,500	62.2	11,500*	11,500*	40
45	36.5	11,900	9,700	47.2	12,100	9,900	53.9	12,100*	10,000	58.7	10,100*	10,100	45
50	27.3	9,900	7,800	41.4	10,100	8,000	49.5	10,200	8,200	55.1	9,000*	8,300	50
55	13.0	8,200	6,400	34.8	8,500	6,600	44.7	8,600	6,700	51.2	8,200*	6,800	55
60	**			26.9	7,200	5,400	39.5	7,300	5,600	47.2	7,300*	5,700	60
65				15.5	6,100	4,500	33.6	6,300	4,600	42.8	6,300	4,700	65
70				**			26.6	5,400	3,800	38.0	5,500	4,000	70
75							17.0	4,600	3,200	32.7	4,700	3,300	75
80							**			26.4	4,000	2,700	80
85										18.1	3,400	2,200	85
90										**			90

### MAXIMUM CAPACITY AT 0 DEGREE BOOM ANGLE

LOAD RADIUS (FT)	BOOM LENGTH 30 FT			BOOM LENGTH 39 FT			BOOM LENGTH 50 FT			BOOM LENGTH 61 FT			BOOM LENGTH 72 FT			BOOM LENGTH 83 FT			BOOM LENGTH 94 FT		
	OVER REAR (LB)	360° (LB)	LOAD RADIUS (FT)	OVER REAR (LB)	360° (LB)	LOAD RADIUS (FT)	OVER REAR (LB)	360° (LB)	LOAD RADIUS (FT)	OVER REAR (LB)	360° (LB)	LOAD RADIUS (FT)	OVER REAR (LB)	360° (LB)	LOAD RADIUS (FT)	OVER REAR (LB)	360° (LB)	LOAD RADIUS (FT)	OVER REAR (LB)	360° (LB)	
25.6	25,700	25,700	34.3	17,700	15,100	45.3	11,300	9,100	56.3	7,800	6,000	67.3	5,600	4,000	78.3	4,000	2,700	89.3	2,900	1,800	

# Lifting Capacities – Pounds (30'– 94' boom and heavy-lift package)

**MODEL T 340**

COUNTERWEIGHT:  
F. BUMPER 1850 LBS.  
UPPERSTRUCTURE:  
W/AUX. WINCH 6100 LBS.  
W/O AUX. WINCH 7200 LBS.

BOOM LENGTH 30-94 FT.  
STABILITY PERCENTAGE  
ON OUTRIGGERS 85%  
ON TIRES 75%  
PCSA CLASS 9-118

**CAUTION:** Do not use this specification sheet as a load rating chart. The format of data is not consistent with the machine chart and may be subject to change.

## ON OUTRIGGERS - MID POSITION

LOAD RADIUS (FT)	BOOM LENGTH 30 FT		BOOM LENGTH 39 FT		BOOM LENGTH 50 FT		BOOM LENGTH 61 FT		BOOM LENGTH 72 FT		BOOM LENGTH 83 FT		BOOM LENGTH 94 FT		LOAD RADIUS (FT)
	LOADED BOOM ANGLE (DEG)	360° (LB)	LOADED BOOM ANGLE (DEG)	360° (LB)	LOADED BOOM ANGLE (DEG)	360° (LB)	LOADED BOOM ANGLE (DEG)	360° (LB)	LOADED BOOM ANGLE (DEG)	360° (LB)	LOADED BOOM ANGLE (DEG)	360° (LB)	LOADED BOOM ANGLE (DEG)	360° (LB)	
9	65.1	77,900*													9
10	63.0	70,000*	69.4	46,600*											10
12	58.5	57,800*	66.2	46,600*	71.7	46,600*									12
15	51.4	37,100	61.2	37,900	68.0	38,500	72.1	38,100*							15
20	37.4	20,700	52.3	21,400	61.6	21,900	67.1	22,200	70.8	22,400					20
25	13.7	13,000	42.0	14,000	54.8	14,400	61.9	14,700	66.5	14,900	69.8	15,000	72.2	15,100	25
30	**		28.8	9,700	47.3	10,200	56.3	10,500	62.0	10,600	66.0	10,800	69.0	10,800	30
35			**		38.7	7,400	50.4	7,700	57.4	7,900	62.2	8,000	65.7	8,100	35
40					27.9	5,500	43.9	5,800	52.5	6,000	58.1	6,100	62.2	6,200	40
45					7.9	3,900	36.5	4,400	47.2	4,500	53.9	4,700	58.7	4,700	45
50					**		27.3	3,200	41.4	3,400	49.5	3,600	55.1	3,600	50
55							13.0	2,300	34.8	2,600	44.7	2,700	51.2	2,800	55
60									26.9	1,800	39.5	2,000	47.2	2,100	60

## \*\* MAXIMUM CAPACITY AT 0 DEGREE BOOM ANGLE

BOOM LENGTH 30 FT		BOOM LENGTH 39 FT		BOOM LENGTH 50 FT		BOOM LENGTH 61 FT		BOOM LENGTH 72 FT		BOOM LENGTH 83 FT		BOOM LENGTH 94 FT	
LOAD RADIUS (FT)	360° (LB)	LOAD RADIUS (FT)	360° (LB)	LOAD RADIUS (FT)	360° (LB)	LOAD RADIUS (FT)	360° (LB)	LOAD RADIUS (FT)	360° (LB)	LOAD RADIUS (FT)	360° (LB)	LOAD RADIUS (FT)	360° (LB)
25.6	12,200	34.3	7,000	45.3	3,800	56.3	2,000						

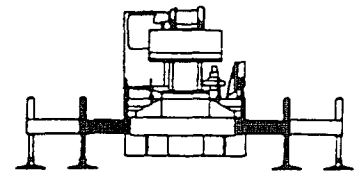

**USE THESE CHARTS  
ONLY WHEN ALL  
OUTRIGGERS ARE PINNED  
IN MID POSITION**

## ON OUTRIGGERS - RETRACTED

LOAD RADIUS (FT)	BOOM LENGTH 30 FT		BOOM LENGTH 39 FT		BOOM LENGTH 50 FT		BOOM LENGTH 61 FT		BOOM LENGTH 72 FT		BOOM LENGTH 83 FT		BOOM LENGTH 94 FT		LOAD RADIUS (FT)
	LOADED BOOM ANGLE (DEG)	360° (LB)	LOADED BOOM ANGLE (DEG)	360° (LB)	LOADED BOOM ANGLE (DEG)	360° (LB)	LOADED BOOM ANGLE (DEG)	360° (LB)	LOADED BOOM ANGLE (DEG)	360° (LB)	LOADED BOOM ANGLE (DEG)	360° (LB)	LOADED BOOM ANGLE (DEG)	360° (LB)	
9	65.1	35,300													9
10	63.0	28,700	69.4	29,400											10
12	58.5	20,500	66.2	21,100	71.7	21,600									12
15	51.4	13,600	61.2	14,200	68.0	14,600	72.1	14,800							15
20	37.4	7,500	52.3	8,200	61.6	8,600	67.1	8,900	70.8	9,000					20
25	13.7	4,100	42.0	5,000	54.8	5,500	61.9	5,700	66.5	5,900	69.8	6,000	72.2	6,100	25
30	**		28.8	2,900	47.3	3,500	56.3	3,700	62.0	3,900	66.0	4,000	69.0	4,100	30
35					38.7	2,100	50.4	2,400	57.4	2,600	62.2	2,700	65.7	2,700	35

## \*\* MAXIMUM CAPACITY AT 0 DEGREE BOOM ANGLE

BOOM LENGTH 30 FT		BOOM LENGTH 39 FT		BOOM LENGTH 50 FT		BOOM LENGTH 61 FT		BOOM LENGTH 72 FT		BOOM LENGTH 83 FT		BOOM LENGTH 94 FT	
LOAD RADIUS (FT)	360° (LB)	LOAD RADIUS (FT)	360° (LB)	LOAD RADIUS (FT)	360° (LB)	LOAD RADIUS (FT)	360° (LB)	LOAD RADIUS (FT)	360° (LB)	LOAD RADIUS (FT)	360° (LB)	LOAD RADIUS (FT)	360° (LB)
25.6	3,600												

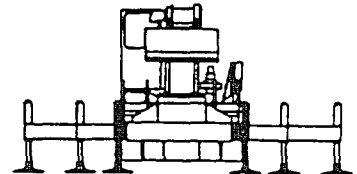

**USE THESE CHARTS WHEN  
ALL OUTRIGGER BEAMS ARE  
NOT IN EITHER THE MID OR  
FULLY EXTENDED POSITION**

# Lifting Capacities – Pounds (30'– 94' boom and heavy-lift package)

## MODEL T 340

COUNTERWEIGHT:  
F. BUMPER 1850 LBS.  
UPPERSTRUCTURE:  
W/AUX. WINCH 6100 LBS.  
W/O AUX. WINCH 7200 LBS.

BOOM LENGTH 30-94 FT.  
STABILITY PERCENTAGE  
ON OUTRIGGERS 85%  
ON TIRES 75%  
PCSA CLASS 9-118

**CAUTION:** Do not use this specification sheet as a load rating chart. The format of data is not consistent with the machine chart and may be subject to change.

### SIDE STOW JIB ON FULLY EXTENDED OUTRIGGERS

LOADED BOOM ANGLE (DEG)	32 FT OFFSETTABLE JIB									49 FT OFFSETTABLE JIB									LOADED BOOM ANGLE (DEG)
	0° OFFSET			15° OFFSET			30° OFFSET			0° OFFSET			15° OFFSET			30° OFFSET			
	LOAD RADIUS (REF) (FT)	REAR ONLY (LB)	360° (LB)	LOAD RADIUS (REF) (FT)	REAR ONLY (LB)	360° (LB)	LOAD RADIUS (REF) (FT)	REAR ONLY (LB)	360° (LB)	LOAD RADIUS (REF) (FT)	REAR ONLY (LB)	360° (LB)	LOAD RADIUS (REF) (FT)	REAR ONLY (LB)	360° (LB)	LOAD RADIUS (REF) (FT)	REAR ONLY (LB)	360° (LB)	
75	38	9,100*	9,100*	46	7,700*	7,700*	52	5,900*	5,900*	41	5,100*	5,100*	55	3,400*	3,400*	62	2,700*	2,700*	75
73	42	8,600*	8,600*	49	7,300*	7,300*	55	5,800*	5,800*	47	4,800*	4,800*	59	3,300*	3,300*	68	2,700*	2,700*	73
71	45	8,200*	8,200*	52	7,000*	7,000*	58	5,600*	5,600*	52	4,500*	4,500*	64	3,200*	3,200*	73	2,600*	2,600*	71
68	50	7,800*	7,400	58	6,200*	6,200*	63	5,100*	5,100*	60	4,100*	4,100*	70	3,000*	3,000*	79	2,500*	2,500*	68
65	56	6,700*	6,300	63	5,500*	5,500*	68	4,600*	4,600*	66	3,800*	3,800*	76	2,900*	2,900*	84	2,500*	2,500*	65
62	61	5,900*	5,000	68	4,900*	4,700	73	4,200*	4,200*	71	3,600*	3,600*	81	2,800*	2,800*	88	2,400*	2,400*	62
59	66	5,200*	4,100	73	4,400*	4,000	77	3,800*	3,800*	77	3,400*	3,400*	86	2,700*	2,700*	93	2,400*	2,400*	59
55	73	4,400*	3,500	79	3,900*	3,300	83	3,400*	3,100	84	3,100*	3,000	93	2,600*	2,400	99	2,300*	2,300	55
51	79	3,800*	2,900	85	3,400*	2,600	88	3,100*	2,500	91	2,900*	2,400	99	2,500*	2,000	105	2,300*	2,000	51
47	86	3,300*	2,300	91	2,900*	2,100	94	2,800*	2,100	100	2,800*	1,900	106	2,400*	1,600	110	2,200*	1,600	47
43	92	2,900*	1,900	97	2,700*	1,700	99	2,500*	1,700	109	2,400*	1,500	112	2,100	1,300	116	2,000*	1,300	43
38	100	2,400*	1,400	103	2,300*	1,300	105	2,200*	1,300	116	2,000	1,000	119	1,800	1,000	122	1,800*	1,000	38
32	106	2,000	900	109	1,900	900	110	1,900*	900	122	1,600	700	126	1,500	600	127	1,500	600	32
25	113	1,600		114	1,600					129	1,300		131	1,200					25
17	118	1,200		118	1,200					133	1,000		135	1,000					17

#### NOTES FOR JIB CAPACITIES

- A. For all boom lengths less than the maximum with a jib erected, the rated loads are determined by boom angle only in the appropriate column.
- B. For boom angle not shown, use the capacity of the next lower boom angle.
- C. Listed radii are for extended main boom only.

### ON TIRES

RADIUS (FT)	MAX BOOM LENGTH (FT)	BOOM STRAIGHT OVER REAR 0 TO 2 1/2 MPH
10	30	19,200
12	30	15,800
15	39	12,100
20	39	7,600
25	50	5,100
30	50	3,600
35	50	2,600
40	50	1,700

#### NOTES FOR ON TIRE CAPACITIES

- A. For Pick and Carry operations, boom must be centered over the front of the crane with swing brake and lock engaged. Use minimum boom point height and keep load close to ground surface.
- B. The load should be restrained from swinging. NO ON TIRE OPERATION WITH JIB ERECTED.
- C. Without outriggers, never maneuver the boom beyond listed load radii for applicable tires to ensure stability.
- D. Creep speed is crane movement of less than 200 Ft. (61m) in a 30 minute period and not exceeding 1.0 mph (1.6 km/h).
- E. Refer to General Notes for additional information.

### MAXIMUM PERMISSIBLE HOIST LINE LOAD

LINE PARTS	1	2	3	4	5	6	7	8	9	10
MAX. LOAD	9,080	18,160	27,240	36,320	45,400	54,480	63,560	72,640	81,720	90,800
BOOM HEAD	2	3-D	2-3	1-4-D	2-3-4	2-3-4-D	1-2-3-4	1-2-3-4-D	1-2-3-4-5	1-2-3-4-5-D
HOOK BLOCK	D	3	3-D	1-4	2-3-D	2-3-4	2-3-4-D	1-2-3-4	1-2-3-4-D	1-2-3-4-5
WIRE ROPE: 5/8" ROTATION RESISTANT COMPACTED STRAND, 18X19 OR 19X19 MINIMUM BREAKING STRENGTH - 22.7 TONS 5/8" 6X19 OR 6X37 IWRC IPS PREFORMED RIGHT REGULAR LAY MINIMUM BREAKING STRENGTH - 17.9 TONS										



# GENERAL NOTES

## GENERAL

1. Rated loads as shown on Lift Charts pertain to this machine as originally manufactured and equipped. Modifications to the machine or use of optional equipment other than that specified can result in a reduction of capacity.
2. Construction equipment can be hazardous if improperly operated or maintained. Operation and maintenance of this machine shall be in compliance with the information in the Operator's, Parts and Safety Manuals supplied with this machine. If these manuals are missing, order replacements from the manufacturer through your distributor.
3. These warnings do not constitute all of the operating conditions for the crane. The operator and job site supervision must read the OPERATORS MANUAL, CIMA SAFETY MANUAL, APPLICABLE OSHA REGULATIONS, AND SOCIETY OF MECHANICAL ENGINEERS (ASME) SAFETY STANDARDS FOR CRANES.
4. This crane and its load ratings are in accordance with POWER CRANE & SHOVEL ASSOCIATION, STANDARD NO. 4, SAE CRANE LOAD STABILITY TEST CODE J765A, SAE METHOD OF TEST FOR CRANE STRUCTURE J1063 AND APPLICABLE SAFETY CODE FOR CRANES, DERRICKS AND MASTS, ASME/ANSI B30.5.

## DEFINITIONS

1. **LOAD RADIUS** – The horizontal distance from the axis of rotation before loading to the center of the vertical hoist line or tackle with a load applied.
2. **LOADED BOOM ANGLE** – It is the angle between the boom base section and the horizontal, after lifting the rated load at the rated radius. The boom angle before loading should be greater to account for deflections. The loaded boom angle combined with boom length give only an approximation of the operating radius.
3. **WORKING AREA** – Areas measured in a circular arc about the centerline of rotation as shown in the diagram.
4. **FREELY SUSPENDED LOAD** – Load hanging free with no direct external force applied except by the hoist rope.
5. **SIDE LOAD** – Horizontal force applied to the lifted load either on the ground or in the air.
6. **NO LOAD STABILITY LIMIT** – The stability limit radius shown on the range diagrams is the radius beyond which it is not permitted to position the boom, when the boom angle is less than the minimum shown on the applicable load chart, because the machine can overturn without any load.

## SET-UP

1. Crane load ratings are based on the crane being leveled and standing on a firm, uniform supporting surface.
2. Crane load ratings on outriggers are based on all outrigger beams being fully extended or in the case of partial extension ratings mechanically pinned in the appropriate position, and the tires free of the supporting surface.
3. Crane load ratings on tires depend on appropriate inflation pressure and the tire conditions. Caution must be exercised when increasing air pressures in tires. Consult Operator's Manual for precautions.
4. Use of jibs, lattice-type boom extensions, or fourth section pullouts extended is not permitted for pick and carry operations.
5. Consult appropriate section of the Operator's and Service Manual for more exact description of hoist line reeving.
6. The use of more parts of line than required by the load may result in having insufficient rope to allow the hook block to reach the ground.
7. Properly maintained wire rope is essential for safe crane operation. Consult Operator's Manual for proper maintenance and inspection requirements.

8. When spin-resistant wire rope is used, the allowable rope loading shall be the breaking strength divided by five (5), unless otherwise specified by the wire rope manufacturer.

## OPERATION

1. **CRANE LOAD RATINGS MUST NOT BE EXCEEDED. DO NOT ATTEMPT TO TIP THE CRANE TO DETERMINE ALLOWABLE LOADS.**
2. When either radius or boom length, or both, are between listed values, the smaller of the two listed load ratings shall be used.
3. Do not operate at longer radii than those listed on the applicable load rating chart (cross hatched areas shown on range diagrams).
4. The boom angles shown on the Capacity Chart give an approximation of the operating radius for a specified boom length. The boom angle, before loading, should be greater to account for boom deflection. It may be necessary to retract the boom if maximum boom angle is insufficient to maintain rated radius.
5. Power telescoping boom sections must be extended equally.
6. Rated loads include the weight of hook block, slings, and auxiliary lifting devices. Their weights shall be subtracted from the listed rated load to obtain the net load that can be lifted.  
When lifting over the jib the weight of any hook block, slings, and auxiliary lifting devices at the boom head must be added to the load.  
When jibs are erected but unused add two (2) times the weight of any hook block, slings, and auxiliary lifting devices at the jib head to the load.
7. Rated loads do not exceed 85% on outriggers or 75% on tires, of the tipping load as determined by SAE Crane Stability Test Code J765a. Structural strength ratings in chart are indicated with an asterisk (\*).
8. Rated loads are based on freely suspended loads. No attempt shall be made to drag a load horizontally on the ground in any direction.
9. The user shall operate at reduced ratings to allow for adverse job conditions, such as: Soft or uneven ground, out of level conditions, high winds, side loads, pendulum action, jerking or sudden stopping of loads, hazardous conditions, experience of personnel, two machine lifts, traveling with loads, electric wires, etc., (side pull on boom or jib is hazardous). Derating of the cranes lifting capacity is required when wind speed exceeds 20 MPH. the center of the lifted load must be allowed to move more than 3' feet off the center line of the boom section due to the effects of wind, inertia, or any combination of the two.  
\*\*Use 2 feet off the center line of the base boom for a two section boom, 3 feet for a three section boom, or 4 feet for a four section boom.
10. The maximum load which can be telescoped is not definable, because of variations in loadings and crane maintenance, but it is permissible to attempt retraction and extension if load ratings are not exceeded.
11. Load ratings are dependent upon the crane being maintained according to manufacturer's specifications.
12. It is recommended that load handling devices, including hooks, and hook blocks, be kept away from boom head at all times.
13. **FOR TRUCK ONLY:** 360° capacities apply only to machines equipped with a front outrigger jack and all five (5) outrigger jacks properly set. If the front (5th) outrigger jack is not properly set, the work area is restricted to the over side and over rear areas as shown on the Crane Working Positions diagram. Use the 360° load ratings in the overside work areas.